



by **ZAVA**

**METALLO NATIVO** COLLECTION





# metallo **NATIVO**

— collection —

Metallo Nativo è il concept firmato Zava con cui l'azienda intende riportare il mondo dell'illuminazione per grandi spazi ad una dimensione primordiale, ponendo l'accento sull'origine della materia e sulla sua valorizzazione estetica ed emozionale. Una linea che vede l'ottone come materia principe: un metallo caratterizzato al contempo da leggerezza estetica e resistenza funzionale dalla nuance unica, vicina all'oro ma più calda e rassicurante. È proprio grazie all'ottone, unito alle possibilità espressive permesse dal tailor-made marchiato Zava, che l'azienda propone oggi una linea di complementi d'illuminazione dal design ricercato e inedito, capaci di risolvere le sfide di progettisti ed interior designer.

*Metallo Nativo is the new concept signed by Zava with which the company intends to bring the world of lighting for large spaces to a primordial dimension, placing the accent on the origin of the material and its aesthetic and emotional enhancement. Brass is the main material: a metal characterised at the same time by aesthetic lightness and functional resistance from the unique nuance, close to the gold but warmer and more reassuring. Thanks to the brass material, combined with the expressive Zava-branded tailor-made design, that the company now offers a collection of lighting accessories with a refined and original design, able to solve the current interior design challenges.*



## Savoir faire.

---

Striving for accuracy.

Zava raffigura le fondamenta nell'arte della lavorazione metallica: un laboratorio sartoriale dove le competenze tecniche e il know-how si associano in un naturale processo con l'eccellenza, espressa dall'attenzione per ogni dettaglio, sapientemente studiato e spinto fino ai massimi livelli estetici. La costante ricerca materica e produttiva firmata Zava, in grado di offrire eccellenza estetica e funzionale, prende vita in ogni prodotto della Collezione *Metallo Nativo*. Un atelier del mondo metallico, in cui il savoir-faire e il know-how permettono di trasformare le idee e l'armonia di linee e curve inizialmente sognate in opere eccezionali e uniche.

*Zava represents the foundations in the art of metalworking: a tailor-made workshop where technical skills and know-how are combined in a natural process with excellence, expressed by the care and attention to every detail, skilfully studied and pushed to the highest aesthetic levels. The ZAVA constant research into materials and products able to offer aesthetic and functional excellence, comes to life in every product of the Collection *Metallo Nativo*. An atelier of the metallic world, where savoir-faire and know-how make allow to transform ideas and harmonious lines into exceptional and unique pieces of works.*

# Designer.



## Brogliato Traverso

Loola

Alberto Brogliato e Federico Traverso fondano BrogliatoTraverso design nel 2012, dopo varie collaborazioni progettuali. La convinzione che poter dar vita agli oggetti che circondano le persone sia un gran privilegio, e la costante passione per ricerca ed innovazione, hanno permesso a BrogliatoTraverso di ricevere vari riconoscimenti internazionali, tra i quali Red Dot Design Award, Good Design Award, iF Design Award, A' Design Award, Young&Design.

*Alberto Brogliato and Federico Traverso based BrogliatoTraverso design in 2012, after various project collaborations. The belief that they can give life to the objects that surround people is a great privilege, and the constant passion for research and innovation, have allowed BrogliatoTraverso to receive several international awards, including the Red Dot Design Award, Good Design Award, iF Design Award, A' Design Award, Young & Design.*

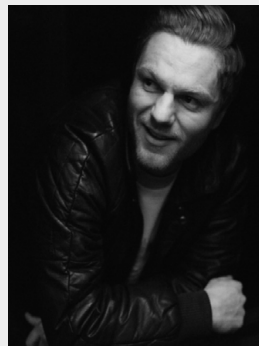

## Studio Douglas James

A-Shade

Direttore creativo, Douglas James McFarlane ha studiato design alla Leeds Met e più recentemente Master in Furniture Design e Tecnologia presso la New Bucks Università laureandosi nel 2012. Con un design ispirato a funzionalità, semplicità e colore, ha creato uno stile distintivo che innova trovando nuovi modi per affrontare ogni aspetto del design. La sua carriera di progettazione, la sua unicità, passione e l'entusiasmo l'ha portato in Italia, Finlandia, Cina e Africa.

*Creative director Douglas James McFarlane studied design at Leeds Met and more recently received a Master in Furniture Design and Technology at New Bucks University, graduating in 2012. With a design inspired by functionality, simplicity and colour, he has created a distinctive style that innovates to find new ways to face every aspect of the design. His design career, with its uniqueness, passion and enthusiasm, has brought him to Italy, Finland, China and Africa.*



## Cédric Davies

Cosima

Cédric Davies ha lavorato come addetto alle produzioni cinematografiche e televisive dove ha sviluppato la sua passione per le luci e le soluzioni di illuminazione. Nel 2006 ha fondato a Monaco di Baviera una società di installazioni elettriche, seguita nel 2013 da DAVIES GmbH, specializzata in consulenza e progettazione illuminotecnica. Questa sinergia tra installazione e progettazione crea sistemi di illuminazione progettati professionalmente, appositamente studiati su misura per le esigenze dei clienti.

*Cédric Davies worked as a gaffer for film and tv productions where he developed his passion for lights and lighting solutions.*

*In 2006 he founded a firm for electric installations in Munich, followed in 2013 by DAVIES GmbH, specialized in light consulting and design.*

*This synergy between installation and design creates professionally designed lighting systems, specially tailored for the needs of his customers.*



## Valerio Cometti + V12 design

Rings

Laureato in Ingegneria Meccanica al Politecnico di Milano, fonda nel 2005 a Milano lo studio "Valerio Cometti+V12 Design". Collaborazioni: Brionvega (televisioni); Leucos (lampade); LaCimbali (macchine caffè); Riva1920 (mobili); Fiam Italia (vetro); Mediaset (elettronica); FEB21st (luxury eyewear). Dal 2009 è columnist di car design per Mondadori.

*Valerio Cometti, graduated in Mechanical Engineering at Milan's Polytechnic, establishes in 2005 "Valerio Cometti+V12 Design" in Milan.*

*Collaborations: Brionvega (television); Leucos (lamps); LaCimbali (coffee machines); Riva1920 (furniture); Fiam Italia (glass); Mediaset (electronics); FEB31st (luxury eyewear). Since 2009, Valerio Cometti is car design columnist for Mondadori.*



## C12+

Dot to dot

C12+ è un progetto collaterale del collettivo torinese C12, attivo dal 2007 nell'ambito del design autoprodotta e di ricerca. C12+ è oggi Anita Donna Bianco, fondatrice di C12, e Gianni Colonello, automotive e industrial designer. Entrambi architetti per formazione e designer per passione, collaborano su progetti che fondono i loro percorsi.

*C12+ is a spinoff project of Torino based C12 work group, founded C12+ in 2007 and active in self produced design and design research. C12+ is formed by Anita Donna Bianco, C12 co-founder, and Gianni Colonello, automotive e industrial designer. Both architects and designers for passion, they collaborate on programs merging their paths.*



## Franco Zavarise

Bull · Mark · Mini Mini · Nox · Pato · Vox

Franco Zavarise nasce a Mareeba, Australia, nel 1960. Dopo gli studi tecnici, matura il desiderio di realizzare corpi illuminanti per gli amici di sempre. Nel 1982 fonda ZAVA, una realtà dinamica in continua espansione. Crede nel design bello, accessibile e sostenibile.

*Franco Zavarise was born in Mareeba, Australia, in 1960. After finishing his technical studies, he developed his great desire: to create lighting structures for his old friends. In 1982 he founded the dynamic and continuously growing ZAVA. He believes in great, affordable and sustainable design.*



## Paolo Ulian

Andromeda

Industrial designer toscano di origine, nei primi anni 1990 è a Milano per lavorare con Enzo Mari. Ha vinto il "Design Report" Award e il premio "Dedalus". Collabora con Droog Design e con alcune aziende italiane tra le quali Driade, Fontana Arte, Zani e Zani, BBB Bonacina, Sensi&C., Coop and Skitsch.

*Industrial designer of Tuscan origin. In the early 1990's he worked in Milan with Enzo Mari. He won the "Design Report" Award and the "Dedalus" award as well. He works together with Droog Design and with Italian companies such as Driade, Fontana Arte, Zani e Zani, BBB Bonacina, Sensi&C., Coop and Skitsch.*

## Sistema ZERO2

Pag. 09

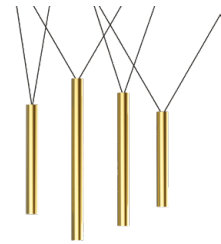

Bull



Nox



Mark



Vox

## Sistema Ragi

Pag. 19



Bull



Nox



Mark



Vox

## Serie collective

Pag. 29



A-Shade  
tavolo · table



A-Shade  
sospensione · suspension



A-Shade  
parete · wall light



A-Shade  
terra · floor



Andromeda  
sospensione · suspension



Andromeda  
parete · wall light



Andromeda  
terra · floor

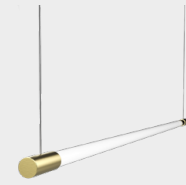

Cosima  
sospensione · suspension



Cosima  
parete · wall light

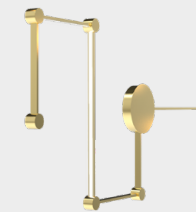

Dot to dot  
parete e plafoniera ·  
wall or ceiling light



Loola  
parete e plafoniera ·  
wall or ceiling light



Loola  
sospensione · suspension



Pato  
terra · floor



Pato  
parete e plafoniera ·  
wall or ceiling light



Rings  
parete e plafoniera ·  
wall or ceiling light



Rings Orizzontale  
sospensione · suspension



Rings Verticale  
sospensione · suspension





## SISTEMA **ZERO2**

UN CAVO. UNA LINEA.  
INFINITE GEOMETRIE POSSIBILI.

Il sistema ZERO2 è caratterizzato da un unico cavo coassiale in PVC semi-opaco nero che compone una linea continua tra le varie sorgenti di luce.

*A CABLE. A LINE.  
INFINITE POSSIBLE GEOMETRIES.*

*The ZERO2 system is characterised by a single coaxial semi-opaque black PVC cable that makes up a continuous line between the various light sources.*

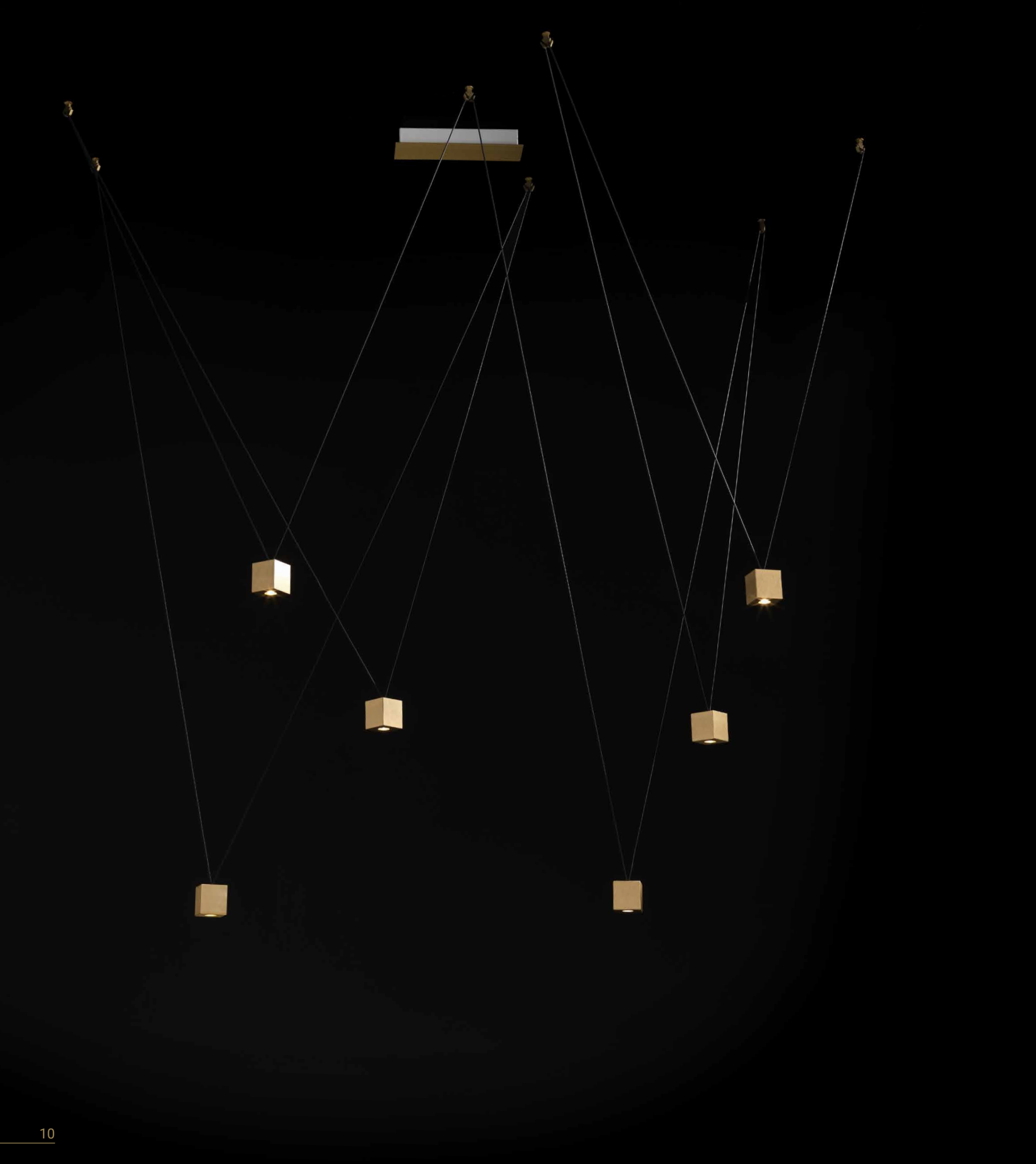

## Sistema ZERO2

Il sistema ZERO2 può essere composto con **quattro diversi paralumi: Bull, Mark, Nox e Vox.** È possibile utilizzare combinazioni di Bull e Mark o, in alternativa, di Nox e Vox in uno stesso sistema ZERO2, con un unico cavo coassiale. Ogni rosone permette di montare al massimo 10 corpi illuminanti per Bull e Mark, 3 per Nox e Vox e massimo 30 metri lineari di cavo coassiale. In caso di composizioni miste, sarà necessario utilizzare più rosone.

*The Zero2 system can be composed by **four different lampshades: Bull, Mark, Nox and Vox.** It is possible to use combinations of Bull and Mark or, alternatively, of Nox and Vox in the same ZERO2 system, with a single coaxial cable. Each canopy allows to mount at most 10 lighting fixtures for Bull and Mark, 3 for Nox and Vox and maximum 30 linear meters of coaxial cable. While mixing compositions, it would be necessary to use more canopies.*

### PARALUMI - LAMPSHADES

Bull

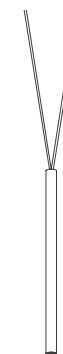

Mark



Nox



Vox



Sistema ZERO2 con paralumi Nox e Vox.  
ZERO2 system with Nox and Vox lampshades.



Paralume Vox ·  
Vox lampshade

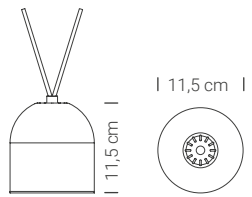

Paralume Nox ·  
Nox lampshade

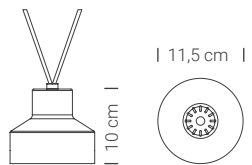



Sistema ZERO2 con paralumi Bull.  
ZERO2 system with Bull lampshades.

Paralume Bull ·  
Bull lampshade

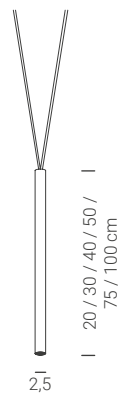





Bull:  
la tecnologia in  
25 mm di diametro

25 mm diameter technology

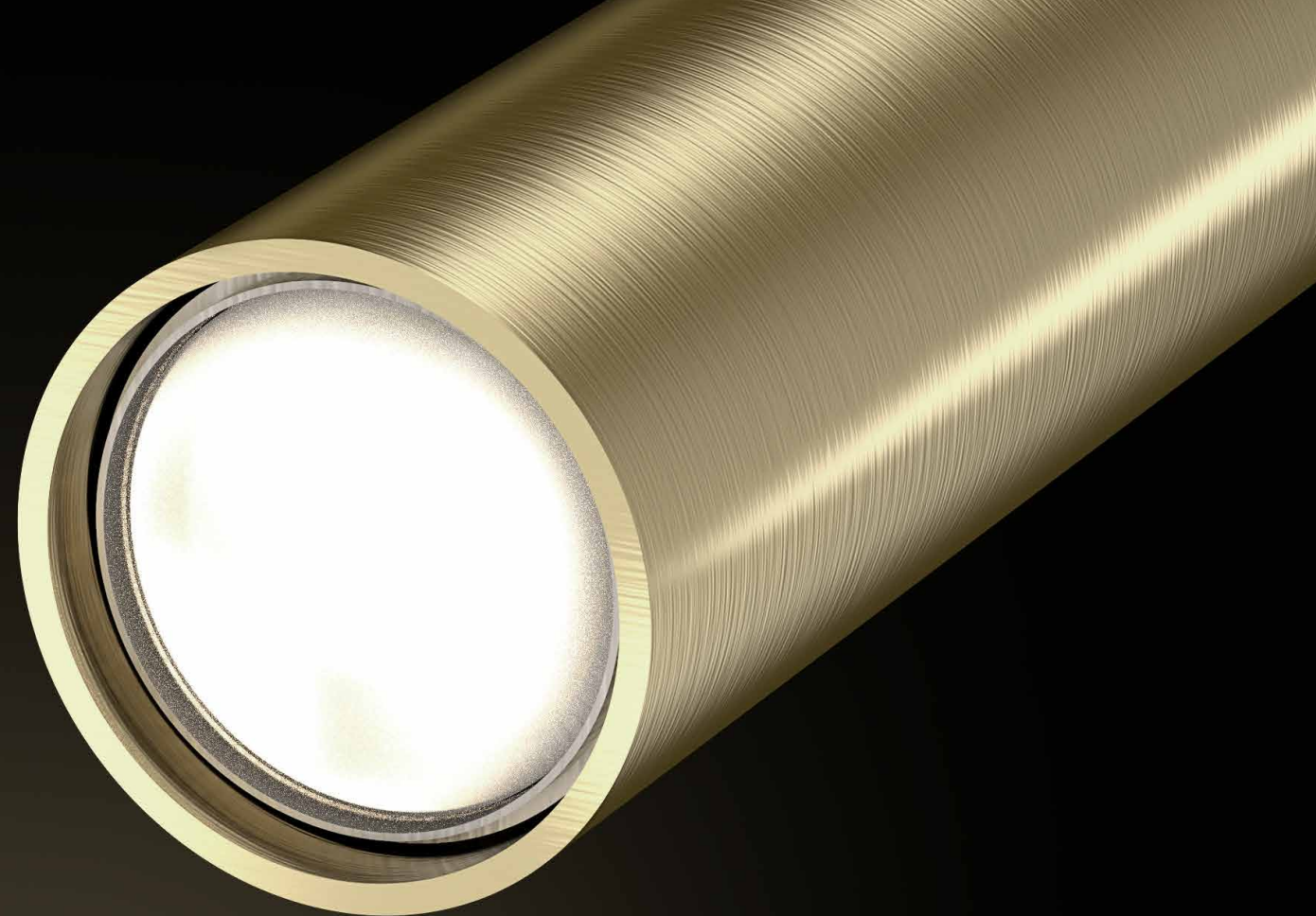

Bull - componente luminosa del Sistema ZERO2 o del Sistema RAGI, presentato nel prossimo capitolo - integra un led con un flusso luminoso di 380 Lm e una resa cromatica >90. La sua lente in vetro appositamente sviluppata e prodotta in Italia per ZAVA consente di ottenere 3 angolazioni diverse di emissione del fascio: 20°, 40°, 60°.

Il Sistema ZERO2 è disponibile sia con sorgente dimmerabile che On/Off, a seconda delle necessità del cliente ed è disponibile in cinque versioni a catalogo: una, tre, quattro, sei o otto Bull con un rosone. La lunghezza del cavo in ogni composizione è di 30 metri di sviluppo e può supportare fino a 10 paralumi. In caso di richiesta di composizione custom, l'ufficio tecnico ZAVA fornisce assistenza completa nella progettazione illuminotecnica.

*Bull - luminous component of the ZERO2 System or the RAGI System, presented in the next chapter - integrates a LED with a luminous flux of 380 Lm and a color rendering index >90. Its glass lens specially developed and produced in Italy for ZAVA allows to obtain 3 different beam angles: 20°, 40°, 60°. The ZERO2 system is available both with a dimmable and an On / Off source, depending on the customer's needs; it is available in five versions: one, three, four, six or eight Bull with a ceiling rose. The length of the cable in each composition has a maximum length of 30 meters and can support up to 10 lampshades. In case of request for custom composition, ZAVA technical department provides complete assistance in lighting design.*



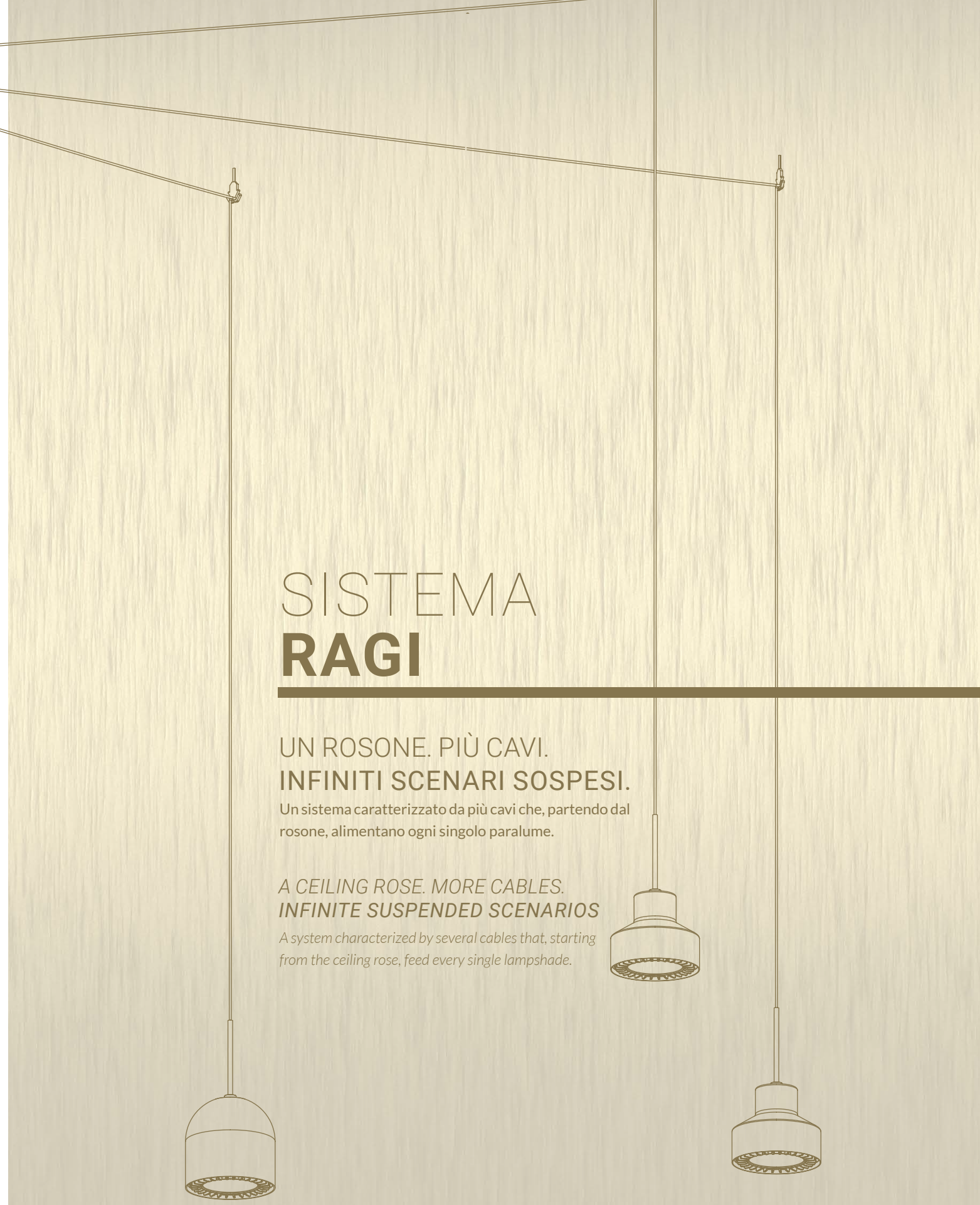

## SISTEMA **RAGI**

UN ROSONE. PIÙ CAVI.  
INFINITI SCENARI SOSPESI.

Un sistema caratterizzato da più cavi che, partendo dal rosone, alimentano ogni singolo paralume.

*A CEILING ROSE. MORE CABLES.  
INFINITE SUSPENDED SCENARIOS*

*A system characterized by several cables that, starting from the ceiling rose, feed every single lampshade.*





## Sistema RAGI

Il sistema RAGI è composto da più Bull, Mark, Nox e Vox con un cavo coassiale in PVC semi-opaco nero. È possibile utilizzare combinazioni di Bull e Mark o, in alternativa, di Nox e Vox in uno stesso sistema Ragi.

*The RAGI system consists of several Bull, Mark, Nox and Vox with a coaxial semi-opaque black PVC cable. It is possible to use combinations of Bull and Mark or, alternatively, of Nox and Vox in the same Ragi system.*

RADIALE · RADIAL

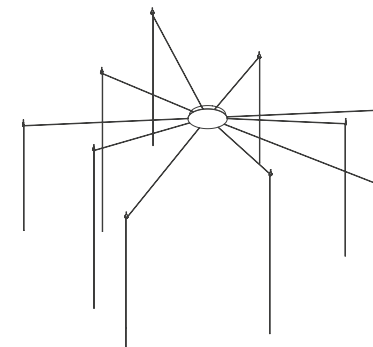

ANGOLARE · ANGULAR

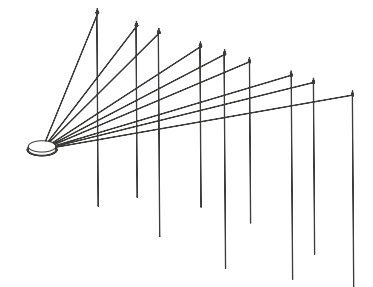

PARALUMI · LAMPSHADES

Bull



Mark



Nox

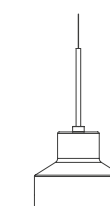

Vox

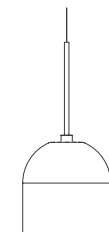



Sistema Ragi con paralumi Nox e Vox.  
Ragi system with Nox and Vox lampshades.



Paralume Vox ·  
Vox lampshade

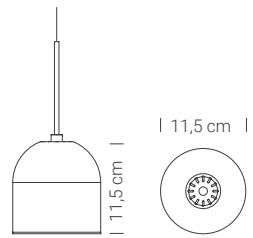

Paralume Nox ·  
Nox lampshade

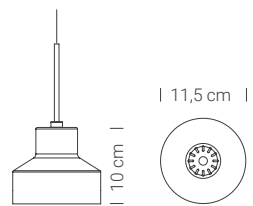

Sistema Raggi con paralume Mark.  
Raggi system with Mark lampshade.



Paralume Mark ·  
Mark lampshade

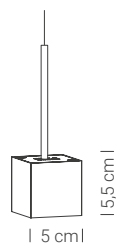



Mark:  
un concentrato di  
tecnologia in 678 g

A concentrate of technology in 678 g.

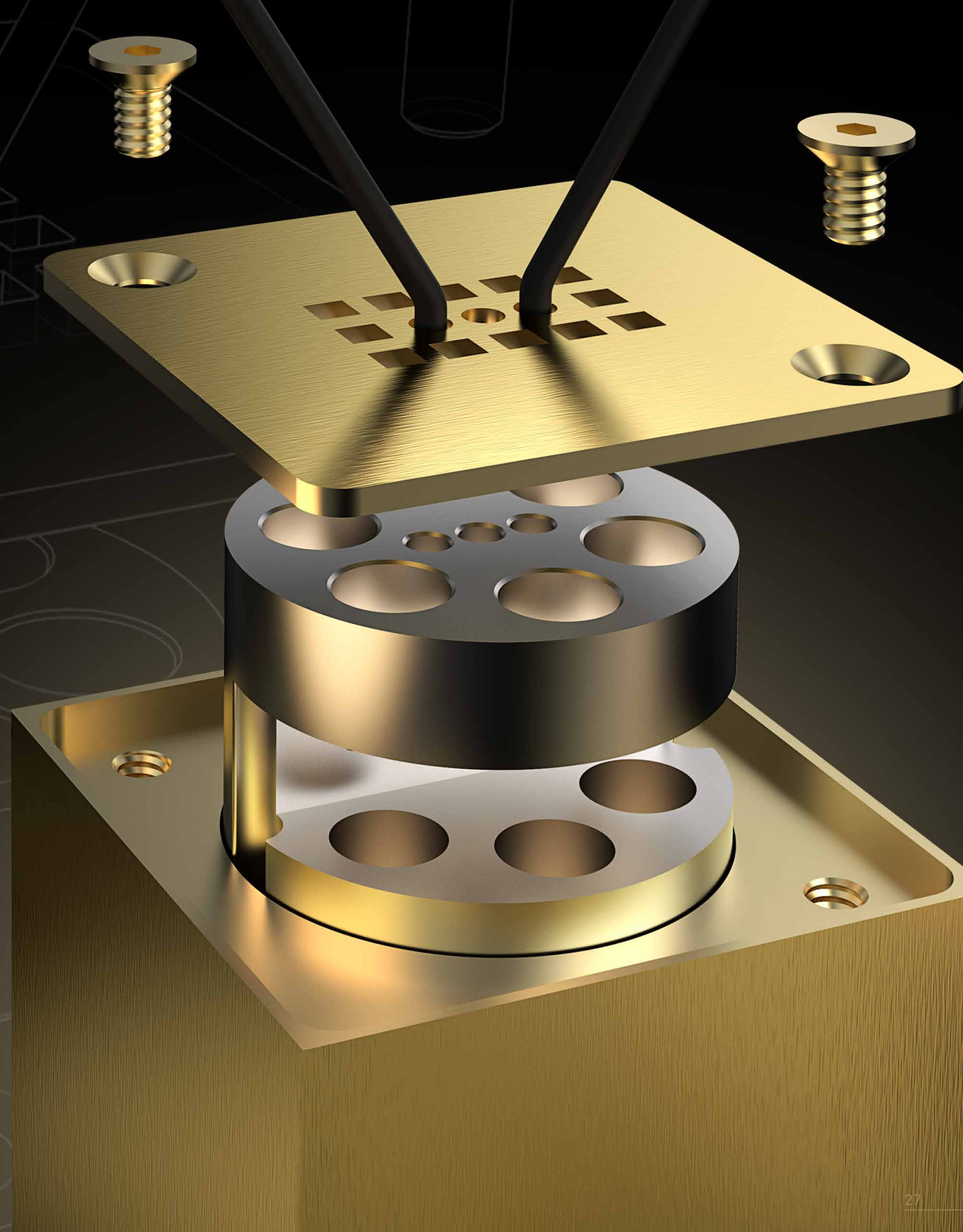

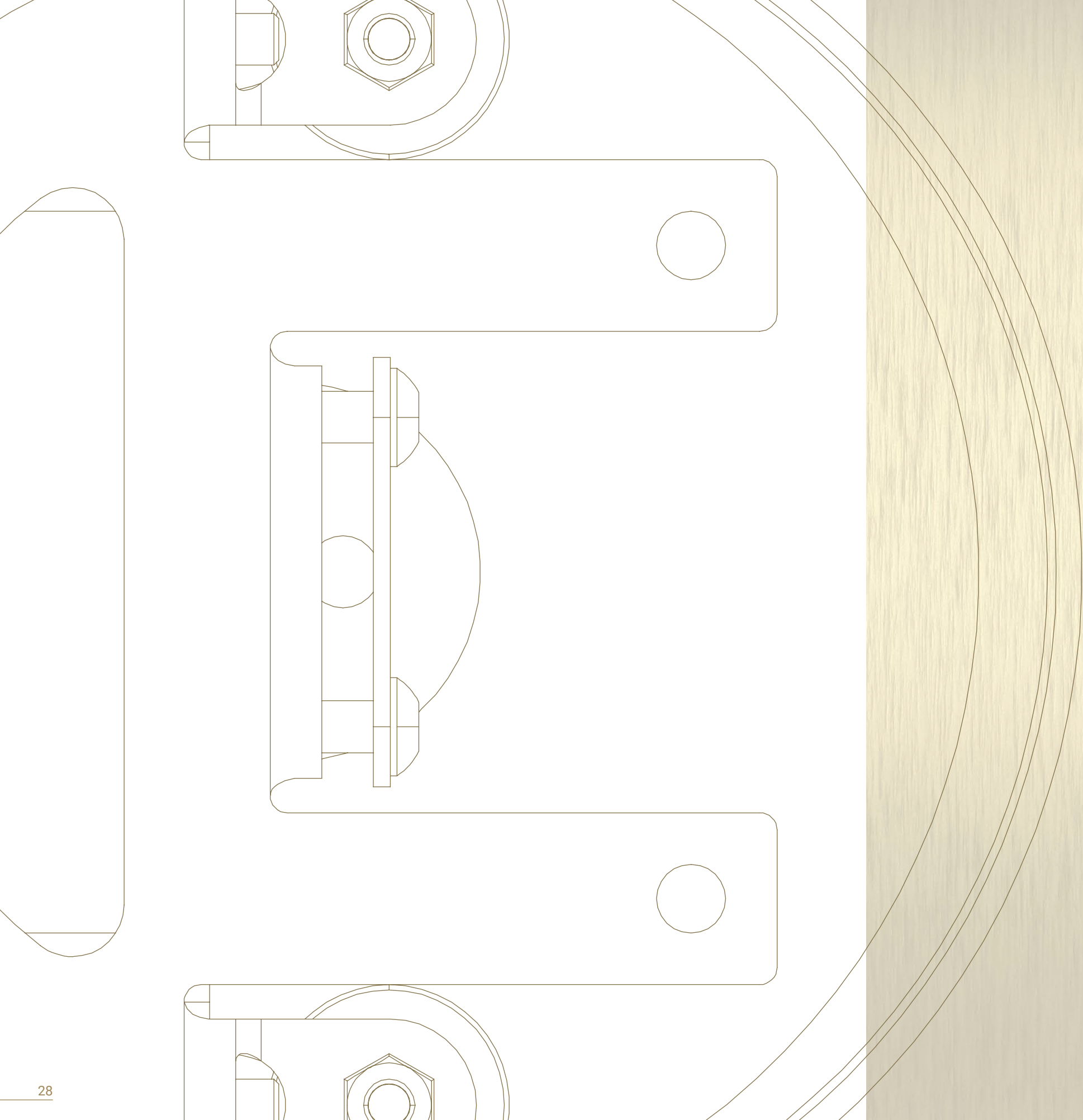

# SERIE **COLLECTIVE**

UN PRODOTTO. MILLE COMBINAZIONI.  
*ONE PRODUCT. A THOUSAND COMBINATIONS.*

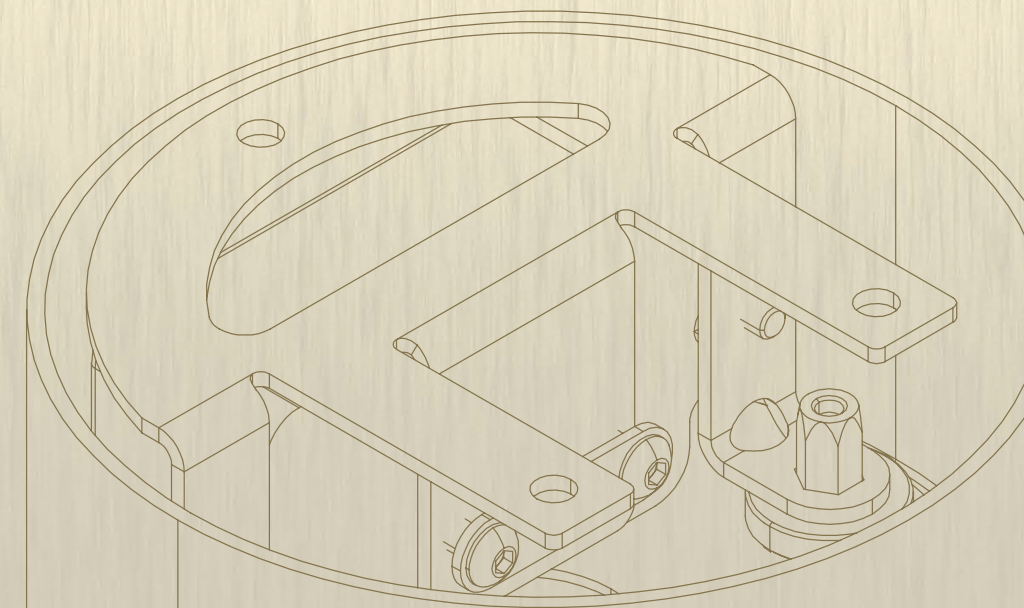





Rings \_ Design Valerio Cometti + V12 design

## Volumi scultorei, libertà, leggerezza.

Sculptural volumes, freedom, lightness.

Una famiglia di lampade pensate per installazioni importanti che danno la possibilità di "disegnare" forme e descrivere volumi scultorei in libertà e con grande leggerezza, semplicemente fornendo degli anelli di luce, rigidi ma eterei. Gli anelli di Rings sono disponibili in diversi diametri ed ogni anello è indipendente ed è possibile creare composizioni di qualsiasi forma e dimensione.

*A family of lamps designed for important installations that give the possibility to "draw" shapes and describe sculptural volumes in freedom and with great lightness, simply by providing rings of light, rigid but ethereal. Rings of Rings are available in different diameters and each ring is independent and it is possible to create compositions of any shape and size.*



Sospensione verticale  
Vertical suspension



Sospensione orizzontale  
Horizontal suspension



Parete e plafoniera  
Wall or ceiling light



Rings sospensione verticale  
*Rings vertical suspension*

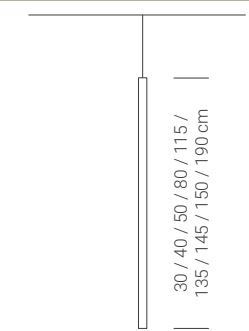

Rings sospensione orizzontale  
*Rings horizontal suspension*

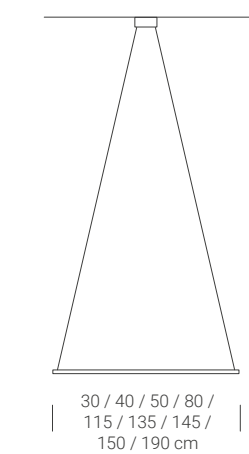



Rings parete e plafoniera  
*Rings wall and ceiling light*

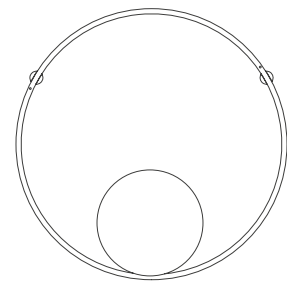

30 / 40 / 50 / 80  
115 / 135 / 145 / 150 / 190 cm



## La migliore potenza in 6 mm di spessore.

The best power in 6 mm thickness

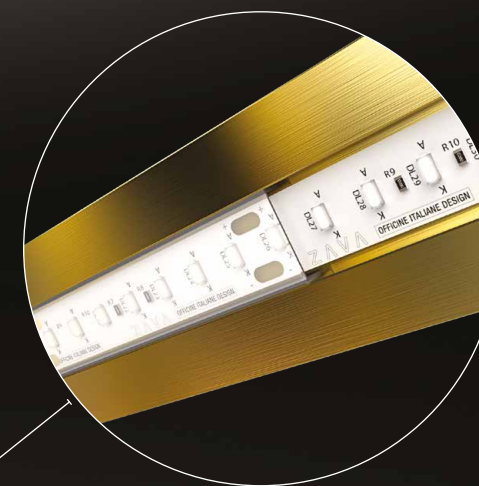

Rings è un anello di luce il cui spessore è pari a solo 6 mm.

Tenendo fissa la sezione millimetrica a questa misura ridottissima, Rings copre diversi diametri, arrivando ad una dimensione di 1900 mm. Ciò è permesso da una tecnologia led ad alte prestazioni che consente di soddisfare ogni esigenza, grazie alle due tipologie di LED differenti a disposizione. Il primo è un LED ad alta efficienza con 147 LED/m e resa cromatica >90, capace di ridurre i consumi energetici. Il secondo è invece un LED ad alto flusso luminoso, con 224 LED/m e una resa cromatica >90, capace di garantire uno straordinario comfort visivo: l'elevato numero di led presenti rendono l'apparecchio quasi privo di punti luminosi percepibili. La soluzione più indicata in caso di particolari esigenze progettuali, come in ampi spazi che necessitano di una maggiore illuminazione. Ogni strip LED è realizzata in Italia su specifiche ZAVA.

*Rings is a ring of light whose thickness is 6 mm only.*

*Keeping the millimetre section fixed to this very small size, Rings have different diameters, reaching a dimension of 1900 mm. This is allowed thanks to a high performance LED technology that allows to meet every requirement, thanks to the two types of different LED available. The first is a high efficiency LED with 147 LED/m and colour rendering index >90, able to reduce energy consumption. The second is a LED with a high luminous flux, with 224 LED/m and a colour rendering index >90, able to guarantee extraordinary visual comfort: the high number of LED make the luminaire almost without perceivable points of light. It is the most suitable solution in case of particular design requirements, as in large spaces that need more lighting. Each LED strip is made in Italy on ZAVA specifications.*





Loola \_ Design BrogliatoTraverso

## Un grande cerchio di luce, puro ed essenziale.

A big light circle, pure and essential.

Una forma pura ed essenziale custodita dal delicato abbraccio dei due anelli che ne fanno da cornice.

Loola ha un driver dimmerabile standard DALI, PUSH, 0-10V, 1-10V.

*A pure and minimal shape guarded by the delicate embrace of the two rings that encircle it. Loola has a standard DALI, PUSH, 0-10V, 1-10V dimmable driver.*



Loola parete e plafoniera  
Loola wall or ceiling light



Loola sospensione  
Loola suspension



Loola sospensione  
*Loola suspension*

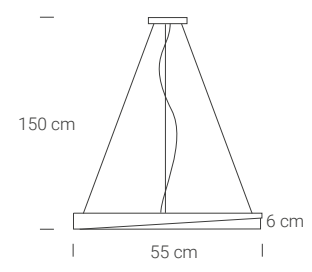

Loola parete e plafoniera  
*Loola wall and ceiling light*

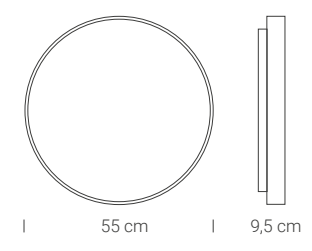



A-Shade \_ Design Studio Douglas James

## Uno stile minimal che procede per sottrazione.

A minimalist style, which proceeds by subtraction.

Si ispira ad uno stile minimal la sospensione A-Shade che procede per sottrazione e riduce all'essenzialità la forma senza intaccare la funzione di corpo illuminante: un apparecchio filiforme con lampadina a vista e il riflesso luminoso che aggiunge una nuova dimensione.

*A-Shade lamp is inspired by a minimalist style, which proceeds by subtraction and reduces the shape to essentiality without damaging its lighting function: a thread-like luminaire with exposed bulb and reflection that adds a new dimension.*

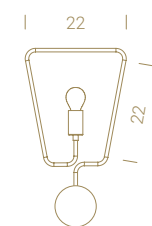

Parete singola  
Single wall light

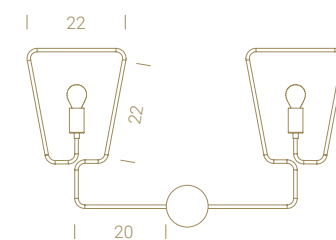

Parete doppia  
Double wall light

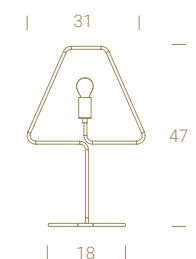

Tavolo · Table

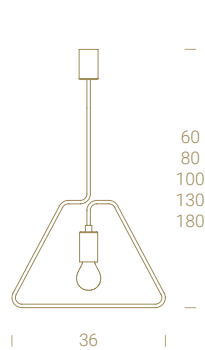

Sospensione · Suspension

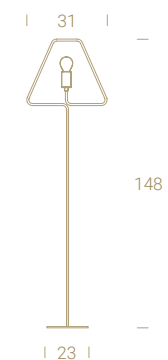

Terra · Floor





Andromeda \_ Design Paolo Ulian

Infinite configurazioni formali.

---

Endless formal configurations.





Andromeda terra  
*Andromeda floor*

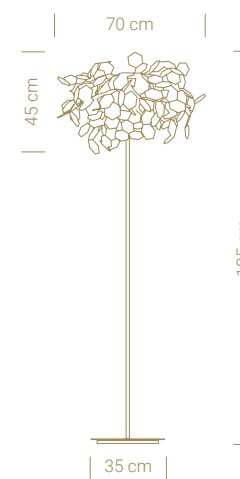





Andromeda parete  
*Andromeda wall light*

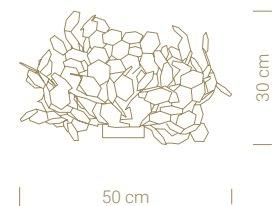

Andromeda sospensione  
*Andromeda suspension*

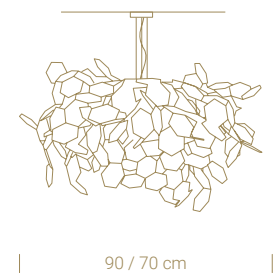





Pato \_ Design Franco Zavarise

## Un tratto materico e minimale disegna lo spazio.

A materic and minimal line draws the space.

Uno stelo in rame che si può piegare a piacere per creare la silhouette preferita. Un'atmosfera vintage per una lampada di grande effetto decorativo.

*A copper rod that can be bent as desired to create the preferred silhouette. A vintage atmosphere offered by a lamp that provides an impressive, decorative effect.*



Parete e plafoniera  
Wall and ceiling lamp



Terra - Floor

Cosima \_ Design César Davies

## Elegante funzionalità.

---

Elegant functionality.





Cosima sospensione  
*Cosima suspension*

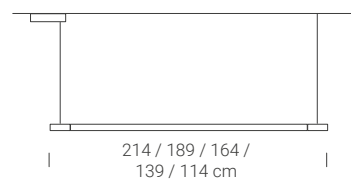

Cosima parete  
*Cosima wall light*



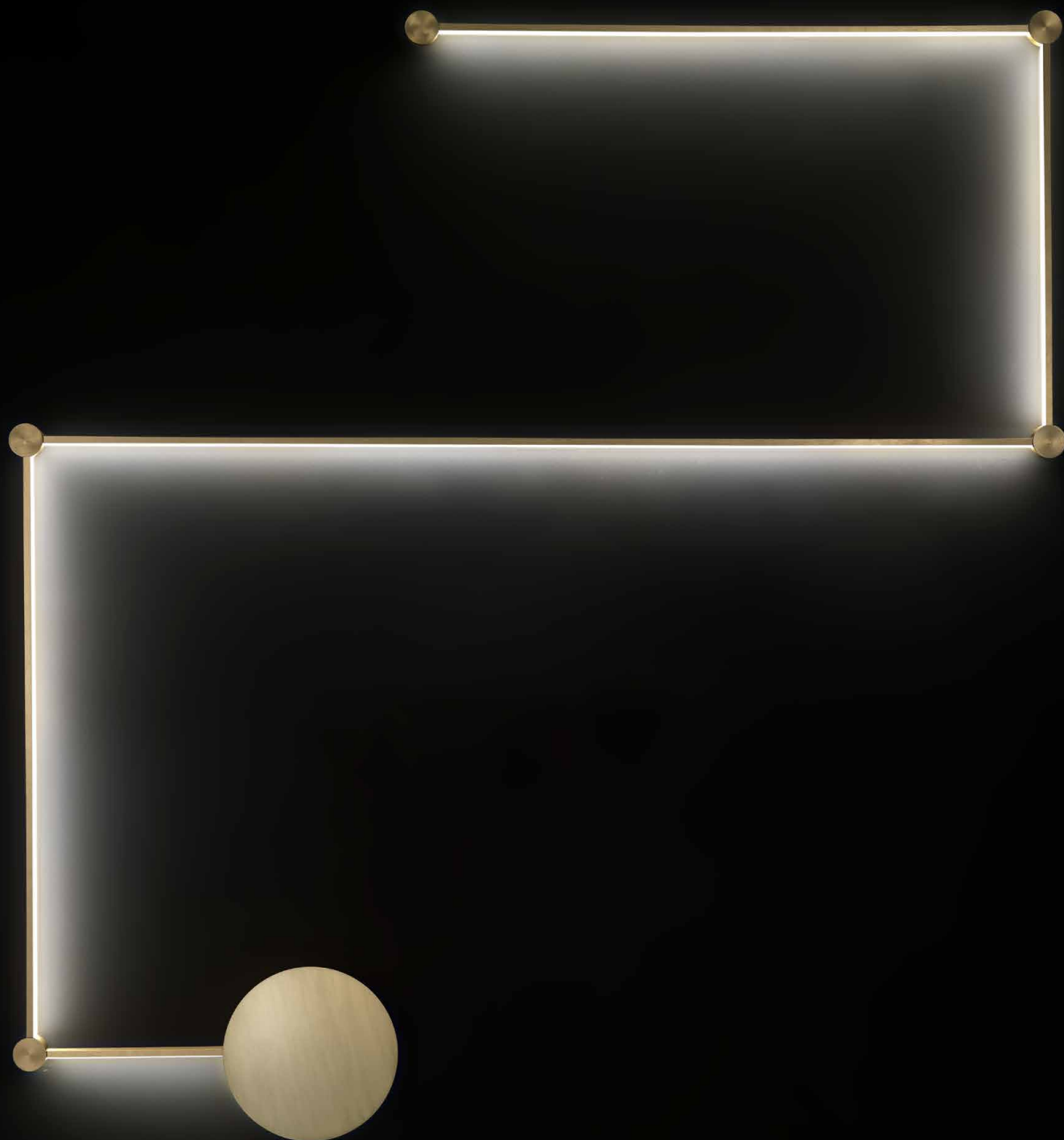

Dot to dot \_ Design C12+

## Soluzioni infinite.

---

Infinite solutions.

Una lampada da parete o soffitto componibile che permette di ottenere infinite soluzioni formali. I singoli bracci, che incorporano la strip LED, sono disponibili in sei diverse lunghezze, da usare singolarmente o da associare tra loro grazie agli snodi circolari. Definendo zone di luce e ombra, il fascio di luce radente permette di creare disegni luminosi personalizzati.

*A composable wall or ceiling light lamp that allows to create infinite formal solutions. The light elements, that incorporate a LED strip, are available in six different lengths and can be used individually or combined thanks to their circular junction. Outlining areas of shadows and lights, the light beam allows to create your own light designs.*



Dot to dot  
parete e plafoniera  
*Dot to dot*  
wall and ceiling light

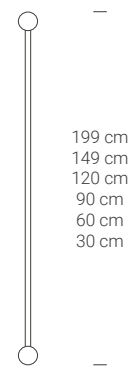

199 cm  
149 cm  
120 cm  
90 cm  
60 cm  
30 cm



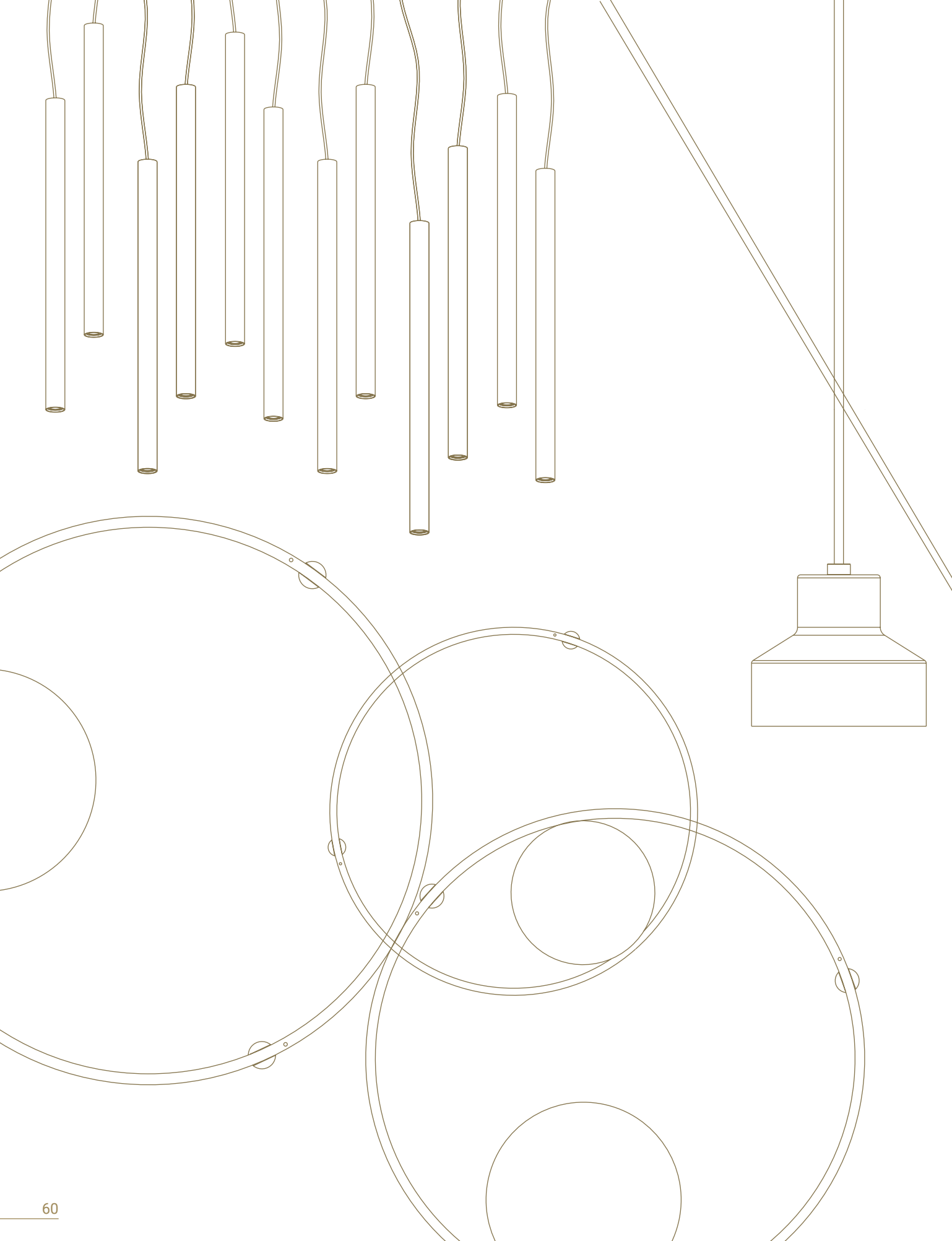

## CORPI ILLUMINANTI LUMINAIRES

Vengono di seguito riportati tutti i dati dimensionali ed illuminotecnici di ogni singolo apparecchio, utili alla progettazione architettonica. Tutti i prodotti con sorgente LED necessitano di un driver per il corretto funzionamento.

*Below are reported all the dimensional and lighting datas of each individual device, useful for architectural design. All products with LED light source require a driver for their correct operation.*



## A-SHADE

sospensione • suspension

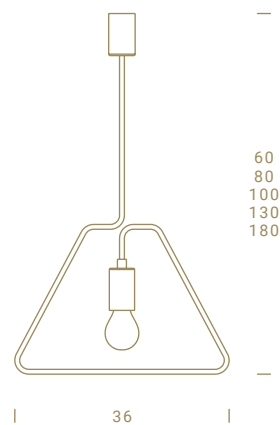

Materiale • Material: Ottone • Brass

--

Sorgente luminosa • Light source E27:

Lampadina esclusa • Bulb not included {A++ -> E}

Attacco • Lampholder E27 Max 70W

--

DIMENSIONI • DIMENSIONS

36 x 60/80/100/130/180 cm

## A-SHADE

parete • wall light

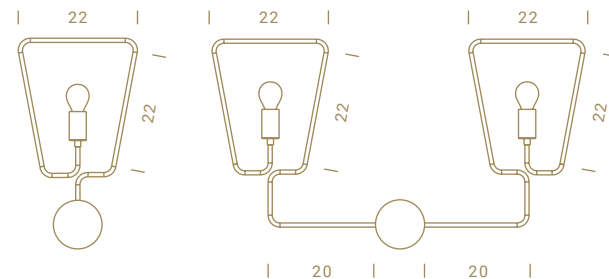

Materiale • Material: Ottone • Brass

--

Sorgente luminosa • Light source E27:

Lampadina esclusa • Bulb not included {A++ -> E}

Attacco • Lampholder E27 Max 70W

--

DIMENSIONI • DIMENSIONS

Singola • Single: 22 x 22

Doppia • Double: 70 x 32

## ANDROMEDA

sospensione • suspension

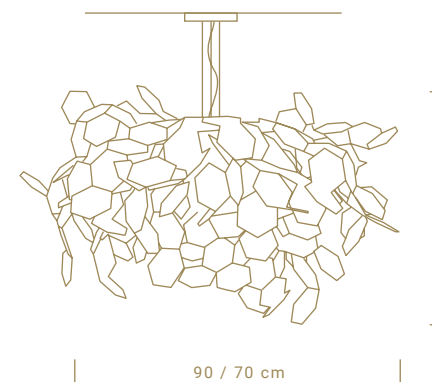

Materiale • Material: Ottone, Ferro • Brass, Iron

--

Sorgente luminosa • Light source E27

Lampadina esclusa • Bulb not included {A++ -> E}

Attacco • Lampholder E27 Max 100W

--

DIMENSIONI • DIMENSIONS

70 x 45 cm

90 x 60 cm

## ANDROMEDA

parete • wall light

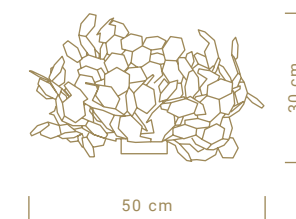

Materiale • Material: Ottone, Ferro • Brass, Iron

--

Sorgente luminosa • Light source LED:

1x8W 230V 3000K 1000Lm En. class A

--

DIMENSIONI • DIMENSIONS

50 x 30 cm

--

Driver ON/OFF incluso • ON/OFF driver included

Dimmerabile DALI/PUSH su richiesta •

DALI/PUSH Dimmable on request

## A-SHADE

terra • floor



Materiale • Material: Ottone, Ferro • Brass, Iron

--

Sorgente luminosa • Light source E27:

Lampadina esclusa • Bulb not included {A++ -> E}

Attacco • Lampholder E27 Max 70W

--

DIMENSIONI • DIMENSIONS

31 x 148 cm / Base • Base 23 cm

## A-SHADE

tavolo • table

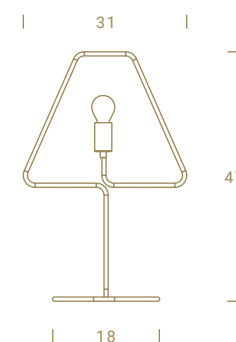

Materiale • Material: Ottone, Ferro • Brass, Iron

--

Sorgente luminosa • Light source E27:

Lampadina esclusa • Bulb not included {A++ -> E}

Attacco • Lampholder E27 Max 70W

--

DIMENSIONI • DIMENSIONS

31 x 47 cm / Base • Base 18 cm

## ANDROMEDA

terra • floor

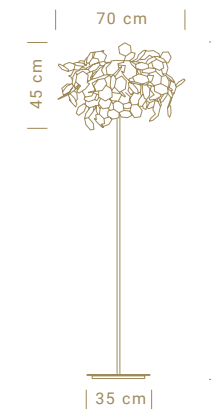

Materiale • Material: Ottone, Ferro • Brass, Iron

--

Sorgente luminosa • Light source E27

Lampadina esclusa • Bulb not included {A++ -> E}

Attacco • Lampholder E27 Max 100W

--

DIMENSIONI • DIMENSIONS

70 x 45 x h. 185 cm

## BULL

paralume • lampshade



Materiale • Material: Ottone, Vetro • Brass, Glass

--

Sorgente luminosa • Light source LED:

1x4W 350 mA 2700K/3000K 380Lm CRI>90 En. Class A

Sistema ottico in vetro • Glass optical system

Angoli di emissione disponibili • Available emission angles:

20°, 40°, 60°

--

DIMENSIONI • DIMENSIONS

Ø 2,5 cm - Lunghezza • Length: 20, 30, 40, 50, 75, 100 cm

## COSIMA

parete • wall light



Materiale • Material: Ottone, PMMA • Brass, PMMA

--

Sorgente luminosa • Light source LED:

214cm: 1x26W 24V dc 3000K CRI>90 3500Lm En. class A

189cm: 1x23W 24V dc 3000K CRI>90 3050Lm En. class A

164cm: 1x20W 24V dc 3000K CRI>90 2600Lm En. class A

139cm: 1x17,5W 24V dc 3000K CRI>90 2100Lm En. class A

114cm: 1x14W 24V dc 3000K CRI>90 1700Lm En. class A

--

Alimentatore remoto fornito solo su richiesta •

Remote power supply available only on request.

Dimmerabile DALI / PUSH su richiesta •

DALI/PUSH dimmable on request

## COSIMA

sospensione • suspension

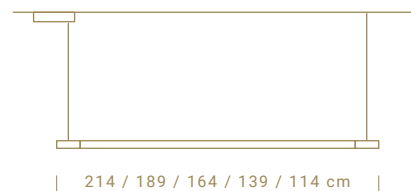

Materiale • Material: Ottone, PMMA • Brass, PMMA

--

Sorgente luminosa • Light source LED:

214cm: 1x26W 24V dc 3000K CRI>90 3500Lm En. class A

189cm: 1x23W 24V dc 3000K CRI>90 3050Lm En. class A

164cm: 1x20W 24V dc 3000K CRI>90 2600Lm En. class A

139cm: 1x17,5W 24V dc 3000K CRI>90 2100Lm En. class A

114cm: 1x14W 24V dc 3000K CRI>90 1700Lm En. class A

--

Alimentatore dimmerabile DALI/PUSH incluso nel rosone

DALI/PUSH dimmable power supply included in the ceiling rose.

## LOOLA

sospensione • suspension

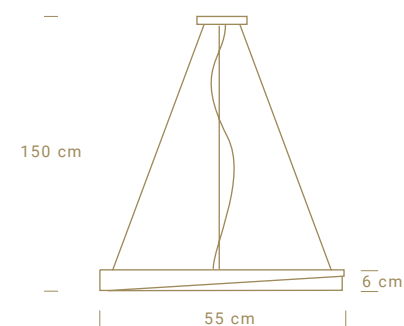

Materiale • Material: Ottone, ferro, PMMA • Brass, iron, PMMA

--

Sorgente luminosa • Light source LED:

1x 31,5W 230V 3000K/4000K 4000lm/4280lm En. Class A

Dimmerabile DALI • Dimmable DALI Push, 0-10V, 1-10V.

--

DIMENSIONI • DIMENSIONS

Apparecchio • luminaire: Ø55 cm h. 6 cm

Rosone • Ceiling rose: Ø 22 cm x h. 4 cm

Lunghezza cavi • Cables length: 1,5 m.

## LOOLA

parete e plafoniera • wall and ceiling light

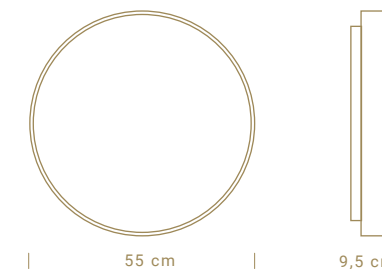

Materiale • Material: Ottone, ferro, PMMA • Brass, iron, PMMA

--

Sorgente luminosa • Light source LED:

1x 31,5W 230V 3000K/4000K 4000lm/4280lm En. Class A

Dimmerabile DALI • Dimmable DALI Push, 0-10V, 1-10V.

--

DIMENSIONI • DIMENSIONS

Apparecchio • Luminaire: Ø55 cm h. 9,5 cm

## DOT TO DOT

parete e plafoniera • wall and ceiling light

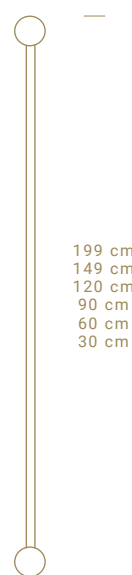

Materiale • Material:

Ottone, Ferro, alluminio • Brass, Iron, aluminium

--

Dimensioni • Dimensions:

Rosone con alimentatore • Rosette with power supply unit:

Ø260 - h. 45 mm

Connettori • Terminals: Ø 50 - h. 45mm

Angolo da 45°, da 90° e 135° • Angle 45°, 90° and 135°

--

Sorgente luminosa • Light source LED:

199cm: 1x32W 24V dc 2700K/3000K/4000K 3040Lm En. class A

149cm: 1x24W 24V dc 2700K/3000K/4000K 2280Lm En. class A

120cm: 1x19,2W 24V dc 2700K/3000K/4000K 1820Lm En. class A

90cm: 1x14,4W 24V dc 2700K/3000K/4000K 1370Lm En. class A

60cm: 1x9,6W 24V dc 2700K/3000K/4000K 910Lm En. class A

30cm: 1x4,8W 24V dc 2700K/3000K/4000K 450Lm En. class A

--

Dimmerabile DALI/PUSH su richiesta •

DALI/PUSH dimmable on request

Lunghezza massima del sistema modulare su unico

alimentatore 6,00 m • Maximum length of the modular

system on a single power supply unit 6.00 m

## MARK

paralume • lampshade

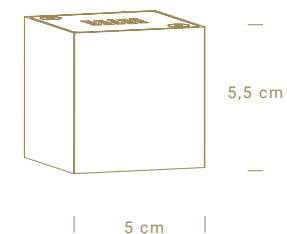

Materiale • Material: Ottone, alluminio • Brass, aluminium

--

Sorgente luminosa • Light source LED:

1x4W 350mA 2700K/3000K 380Lm CRI>90 En. Class A

--

Angoli di emissione disponibili • Available emission angles:

20°, 40°, 60°

--

DIMENSIONI • DIMENSIONS

5 x 5 x 5,5 cm



## NOX

paralume · lampshade



Materiale · Material: Ottone · Brass

--

Sorgente luminosa · Light source LED:  
1x25W 700mA 2700/3000K 2200/2450Lm  
CRI>90 En. Class A

--

DIMENSIONI · DIMENSIONS  
Ø 11,5 cm - Altezza · Height: 10 cm

## VOX

paralume · lampshade



Materiale · Material: Ottone · Brass

--

Sorgente luminosa · Light source LED:  
1x25W 700mA 2700/3000K 2200/2450Lm  
CRI>90 En. Class A

--

DIMENSIONI · DIMENSIONS  
Ø 11,5 cm - Altezza · Height: 11,5 cm

## RINGS

sospensione orizzontale · horizontal suspension



Materiale · Material: Ottone · Brass

--

Dimensione rosone per Rings singolo  
Ceiling rose dimensions for single Rings :  
Ø 30, 40, 50, 80: Ø 20 cm - h. 4 cm  
Ø 115, 135, 145, 150 cm: Ø 26 cm - h. 4 cm  
Ø 190: Ø 33,5 cm - h. 4 cm

sospensione verticale · vertical suspension



Materiale · Material: Ottone · Brass

--

Dimensione rosone per Rings singolo  
Ceiling rose dimensions for single Rings :  
Ø 30, 40: 7,5 x 20 x h. 3,8 cm  
Ø 50, 80: 7,5 x 23,5 x h. 3,8 cm  
Ø 115, 135, 145: 7,5 x 25,5 x h. 3,8 cm  
Ø 150, 190: 9,5 x 28 x h. 3,8 cm

## PATO

terra · floor

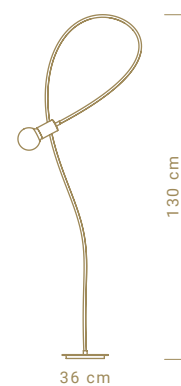

Materiale · Material: Ottone, Ferro, Rame · Brass, Iron, Copper

--

Sorgente luminosa · Light source E27:  
Lampadina esclusa · Bulb not included {A++ -> E}  
Attacco · Lampholder E27 Max 70W

--

DIMENSIONI · DIMENSIONS  
36 x h. 130 cm

## PATO

parete e plafoniera · wall light and ceiling

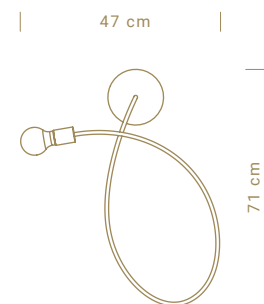

Materiale · Material: Ottone, Ferro, Rame · Brass, Iron, Copper

--

Sorgente luminosa · Light source E27:  
Lampadina esclusa · Bulb not included {A++ -> E}  
Attacco · Lampholder E27 Max 70W

--

DIMENSIONI · DIMENSIONS  
47 x h. 71 cm / Rosone · Rosette: Ø 14,5 x 3 cm

parete e plafoniera · wall and ceiling light

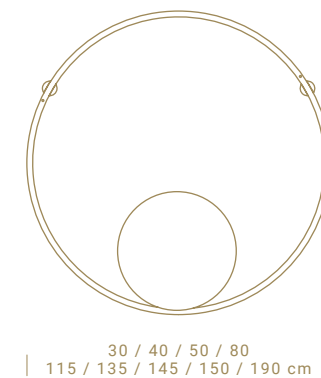

Materiale · Material: Ottone · Brass

--

Dimensione rosone per Rings singolo  
Rosette dimensions for single Rings :  
Ø 30: Ø 11 cm  
Ø 40 cm: Ø 13 cm  
Ø 50, 80 cm: Ø 18,5 cm  
Ø 115, 135, 145 cm: Ø 20,5 cm  
Ø 150, 190 cm: Ø 26 cm

--

Altezza rosone · Rosette height: 4 cm o · or 8 cm

Sorgente luminosa ad alta potenza, CRI>90, 224 led/m

High power light source, CRI>90, 224 led/m

Ø30cm LED 18W 24V dc 3000K 2016Lm  
Ø40cm LED 24W 24V dc 3000K 2674Lm  
Ø50cm LED 30W 24V dc 3000K 3248Lm  
Ø80cm LED 46W 24V dc 3000K 4984Lm  
Ø115cm LED 63W 24V dc 3000K 6804Lm  
Ø135cm LED 70W 24V dc 3000K 7560Lm  
Ø145cm LED 75W 24V dc 3000K 8050Lm  
Ø150cm LED 77W 24V dc 3000K 8288Lm  
Ø190cm LED 88W 24V dc 3000K 9380Lm

--

Sorgente luminosa ad alta efficienza, CRI>90, 147 led/m

High efficiency light source, CRI>90, 147 led/m

Ø30cm LED 17W 24V dc 2700K/3000K 1608Lm 4000K 1900Lm  
Ø40cm LED 23W 24V dc 2700K/3000K 2133Lm 4000K 2520Lm  
Ø50cm LED 28W 24V dc 2700K/3000K 2590Lm 4000K 3061Lm  
Ø80cm LED 43W 24V dc 2700K/3000K 3975Lm 4000K 4697Lm  
Ø115cm LED 59W 24V dc 2700K/3000K 5426Lm 4000K 6413Lm  
Ø135cm LED 65W 24V dc 2700K/3000K 6029Lm 4000K 7125Lm  
Ø145cm LED 69W 24V dc 2700K/3000K 6420Lm 4000K 7587Lm  
Ø150cm LED 71W 24V dc 2700K/3000K 6610Lm 4000K 7811Lm  
Ø190cm LED 80W 24V dc 2700K/3000K 7481Lm 4000K 8841Lm

--

Per entrambe · For both:

Alimentatore incluso nel rosone

Power supply included in the ceiling rose

Dimmerabile DALI/PUSH su richiesta · DALI/PUSH dimmable on request

--

Le dimensioni del rosone nella variante DALI/PUSH possono essere diverse ·

The dimensions of the ceiling rose in the DALI / PUSH variant can be different

--

Sistema modulare componibile e personalizzabile ·

Modular customizable system

Composizioni speciali disponibili su richiesta ·

Special compositions available on request

Zava Srl non concede al possessore la facoltà d'utilizzare il Marchio e immagini comprese in questo documento. Immagini e informazioni utilizzate in questo documento sono di proprietà esclusiva di Zava Srl.

Il possessore non è autorizzato ne a cedere ad altri tali immagini ne a farne oggetto di sfruttamento. Le iniziative pubblicitarie con le immagini dei prodotti e con l'utilizzo del Marchio dovranno essere previamente concordate.

L'azienda si riserva di apportare modifiche e migliorie senza preavviso.

*Zava Srl does not grant the holder the right to use the Trademark and images included in this document. Images and information used in this document are exclusive property of Zava Srl.*

*The holder is not authorised to transfer such images to other or to exploit them. Advertising initiatives with product images and the use of the Trademark must be agreed in advance.*

*The company reserves to make changes and improvements without notice.*



Via Padova, 48 - 31041 Cornuda (TV)  
t. +39 0423 639907 - f. +39 0423 821639  
contatto@zavaluce.it  
www.zavaluce.it

#### **ZAVA \_ Linea Illuminazione**

Concept e progetto grafico · *Concept and graphic project:* Delineodesign® Comunicazione  
Rendering e fotografia · *Rendering and photography:* Asolana Group  
Stampa · *Print:* Grafiche Antiga  
Finito di stampare · *Printed in:* Giugno 2019

Special thanks to: Graziella Paolucci, Franco Zavarise, Federico Budel, Enrico Fabris



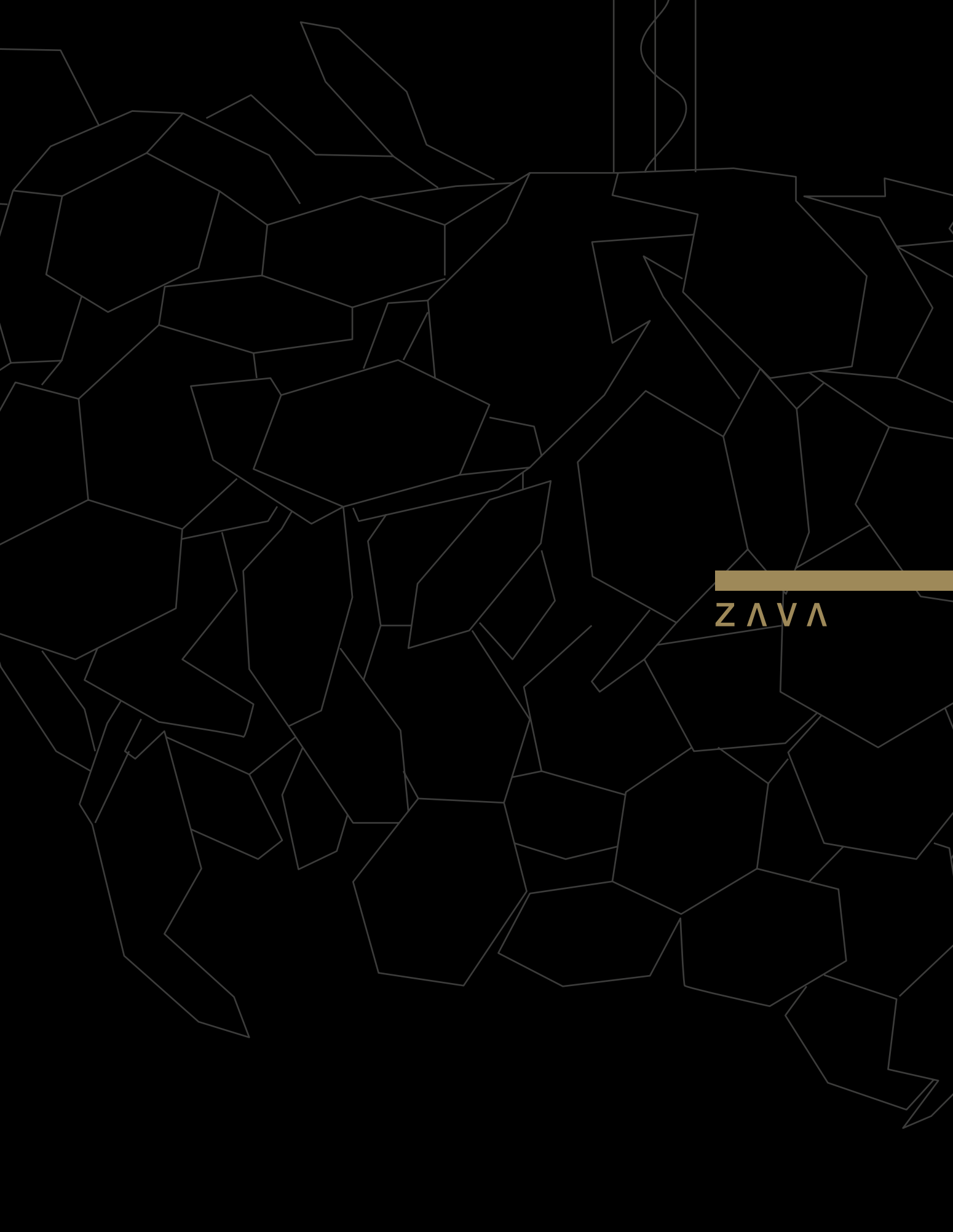

---

ZAVA