

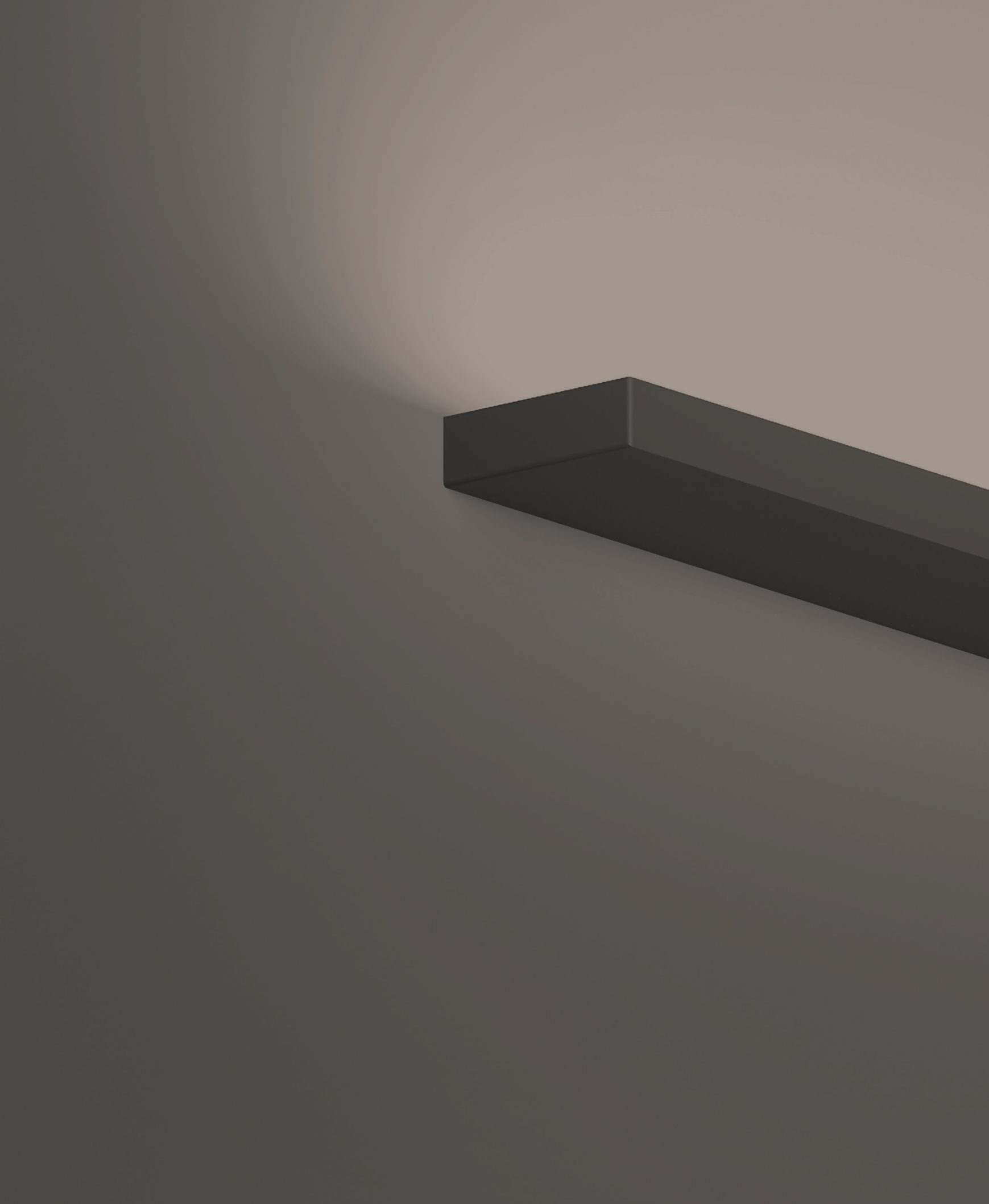

NOVITÀ • NEW PRODUCTS • NEUER PRODUKTE



EUROLUCE 2023



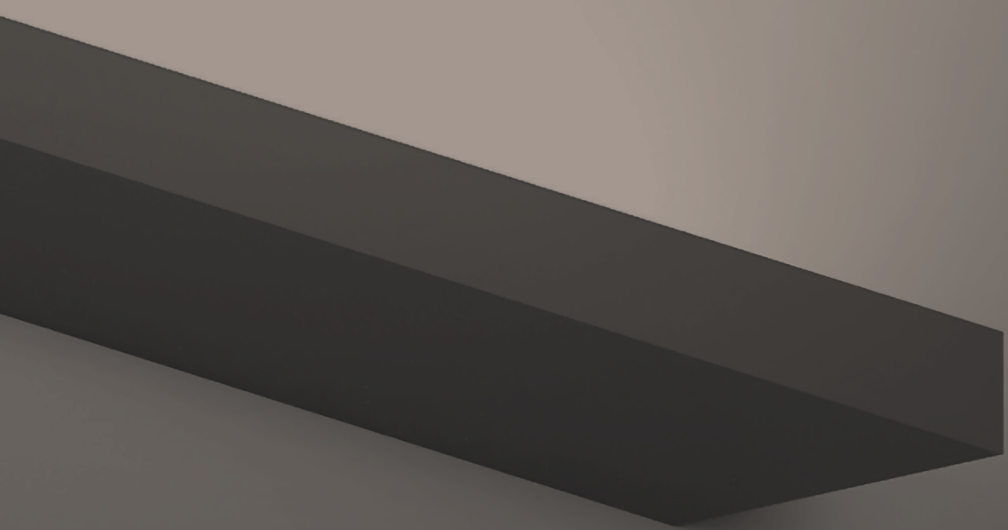

PARETE
WALL LIGHT
WANDLEUCHTE





 **CODICE COMPLETO DEL PRODOTTO NELLA FOTO**
FULL PRODUCT CODE AS SHOWN IN PICTURE • VOLLSTÄNDIGER CODE VOM ARTIKEL IM BILD

2026QOF | **NE** | **E28** | **A**

Codice
Code

Finitura
Finishing
Lackierung

Diffusore
Diffuser
Diffusor

Tonalità
Hue
Farbton



configurazione standard: / basic configuration: / Standard Konfiguration:

E28 Satinato
Frosted - Satinert

B 3000K

BV

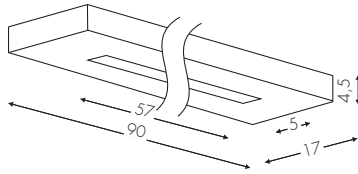

2026QOFBVE28B
2026QDMBVE28B

50W 6500lm + 10W 1500lm - 220V

DALI (Push) - 50W 6500lm + 10W 1500lm - 220V

557,00 €

611,00 €

Configura



Configure / Konfigurieren

www.teamitaliailluminazione.it



A

A 2700K

NE RU

A Alimentatore Incorporato - Incorporated Power Supply - Eingebautes Netzteil

* 6500lm effettivi - effective - effektive con - with - mit **E28**



 **CODICE COMPLETO DEL PRODOTTO NELLA FOTO**
FULL PRODUCT CODE AS SHOWN IN PICTURE • VOLLSTÄNDIGER CODE VOM ARTIKEL IM BILD

2015ATF | **OV** | **E2** | **B**

Codice
Code

Finitura
Finishing
Lackierung

Diffusore
Diffuser
Diffusor

Tonalità
Hue
Farbton



configurazione standard: / basic configuration: / Standard Konfiguration:

E2 Opale - Opal

 B 3000K

BV



2015ATFBVE2B

26W 2295lm* + 13W 1150lm - 220V

460,00 €

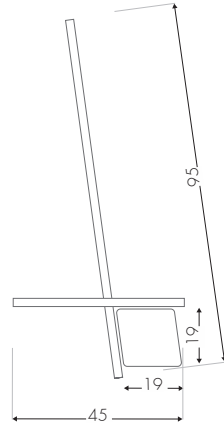
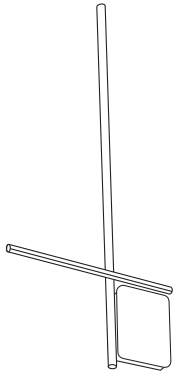

Configura 

Configure / Konfigurieren

www.teamitaliailluminazione.it



 A 2700K



TF Taglio di Fase - Phase-Cut Dimmer - Phasenabschrittdimmer

A Alimentatore Incorporato - Incorporated Power Supply - Eingebautes Netzteil

* 2295lm effettivi - effective - effektive con - with - mit **E2**



 **CODICE COMPLETO DEL PRODOTTO NELLA FOTO**
FULL PRODUCT CODE AS SHOWN IN PICTURE • VOLLSTÄNDIGER CODE VOM ARTIKEL IM BILD

2032BOF

Codice
Code

OV

Finitura
Finishing
Lackierung

E2

Diffusore
Diffuser
Diffusor

A

Tonalità
Hue
Farbton



configurazione standard: / basic configuration: / Standard Konfiguration:

E2 Opale - Opal

B 3000K

BV

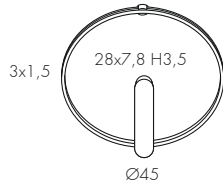

2032COFBVE2B
2032CDMBVE2B
2032CTFBVE2B

25W 1260lm* - 220V
DALI (Push) - 25W 1260lm - 220V
25W 1260lm - 220V

474,00 €
553,00 €
553,00 €

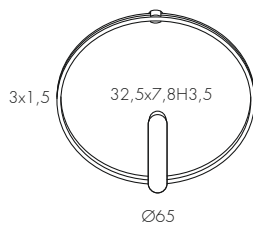

2032AOFBVE2B
2032ADMBVE2B
2032ATFBVE2B

35W 1740lm - 220V
DALI (Push) - 35W 1740lm - 220V
35W 1740lm - 220V

601,00 €
697,00 €
697,00 €

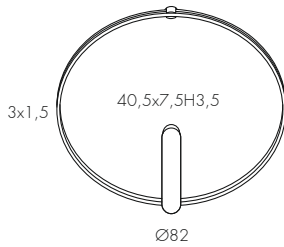

2032BOFBVE2B
2032BDMBVE2B
2032BTFBVE2B

48W 2580lm - 220V
DALI (Push) - 48W 2580lm - 220V
48W 2580lm - 220V

709,00 €
808,00 €
808,00 €

Configura

Configure / Konfigurieren

www.teamitaliailluminazione.it



A 2700K



TF Taglio di Fase - Phase-Cut Dimmer - Phasenabschrittdimmer

A Alimentatore Incorporato - Incorporated Power Supply - Eingebautes Netzteil

* 1260lm effettivi - effective - effektive con - with - mit **E2**

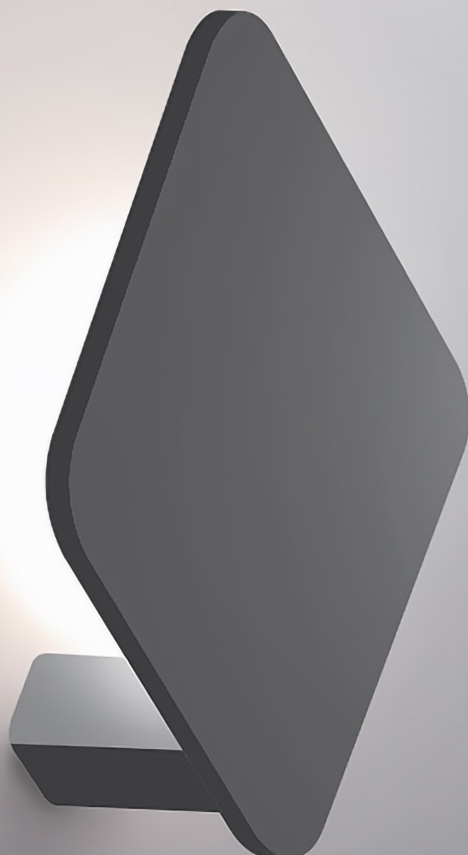

 **CODICE COMPLETO DEL PRODOTTO NELLA FOTO**
FULL PRODUCT CODE AS SHOWN IN PICTURE • VOLLSTÄNDIGER CODE VOM ARTIKEL IM BILD

2018BTF | **BV** | **E28** | **B**

Codice
Code

Finitura
Finishing
Lackierung

Diffusore
Diffuser
Diffusor

Tonalità
Hue
Farbton



configurazione standard: / basic configuration: / Standard Konfiguration:

E28 Satinato
Frosted - Satinert

B 3000K

BV

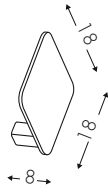

2018BTFBVE28B

18W 1700lm* - 220V

165,00 €

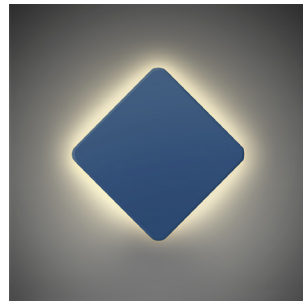
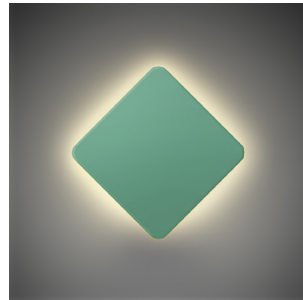

Configura Configure / Konfigurieren

www.teamitaliailluminazione.it



TF Taglio di Fase - Phase-Cut Dimmer - Phasenabschrittdimmer

A Alimentatore Incorporato - Incorporated Power Supply - Eingebautes Netzteil

* 1700lm effettivi - effective - effektive con - with - mit **E28**



 **CODICE COMPLETO DEL PRODOTTO NELLA FOTO**
FULL PRODUCT CODE AS SHOWN IN PICTURE • VOLLSTÄNDIGER CODE VOM ARTIKEL IM BILD

2038AOF | **BV** | **E28** | **B**

Codice
Code

Finitura
Finishing
Lackierung

Diffusore
Diffuser
Diffusor

Tonalità
Hue
Farbton



configurazione standard: / basic configuration: / Standard Konfiguration:

E28 Satinato
Frosted - Satinert

 **B** 3000K

BV

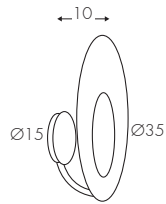

2038AOFBVE28B

15W 1900lm* - 220V

407,00 €

2038ADMBVE28B

DALI (Push) - 15W 1900lm - 220V

478,00 €

2038ATFBVE28B

15W 1900lm - 220V

478,00 €

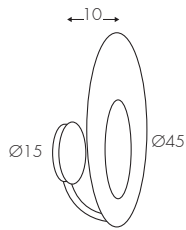

2038BOFBVE28B

18W 2600lm - 220V

464,00 €

2038BDMBVE28B

DALI (Push) - 18W 2600lm - 220V

531,00 €

2038BTFBVE28B

18W 2600lm - 220V

531,00 €

Configura 

Configure / Konfigurieren

www.teamitaliailluminazione.it



 **A** 2700K



TF Taglio di Fase - Phase-Cut Dimmer - Phasenabschnittdimmer

A Alimentatore Incorporato - Incorporated Power Supply - Eingebautes Netzteil

* 1900lm effettivi - effective - effektive con - with - mit **E28**



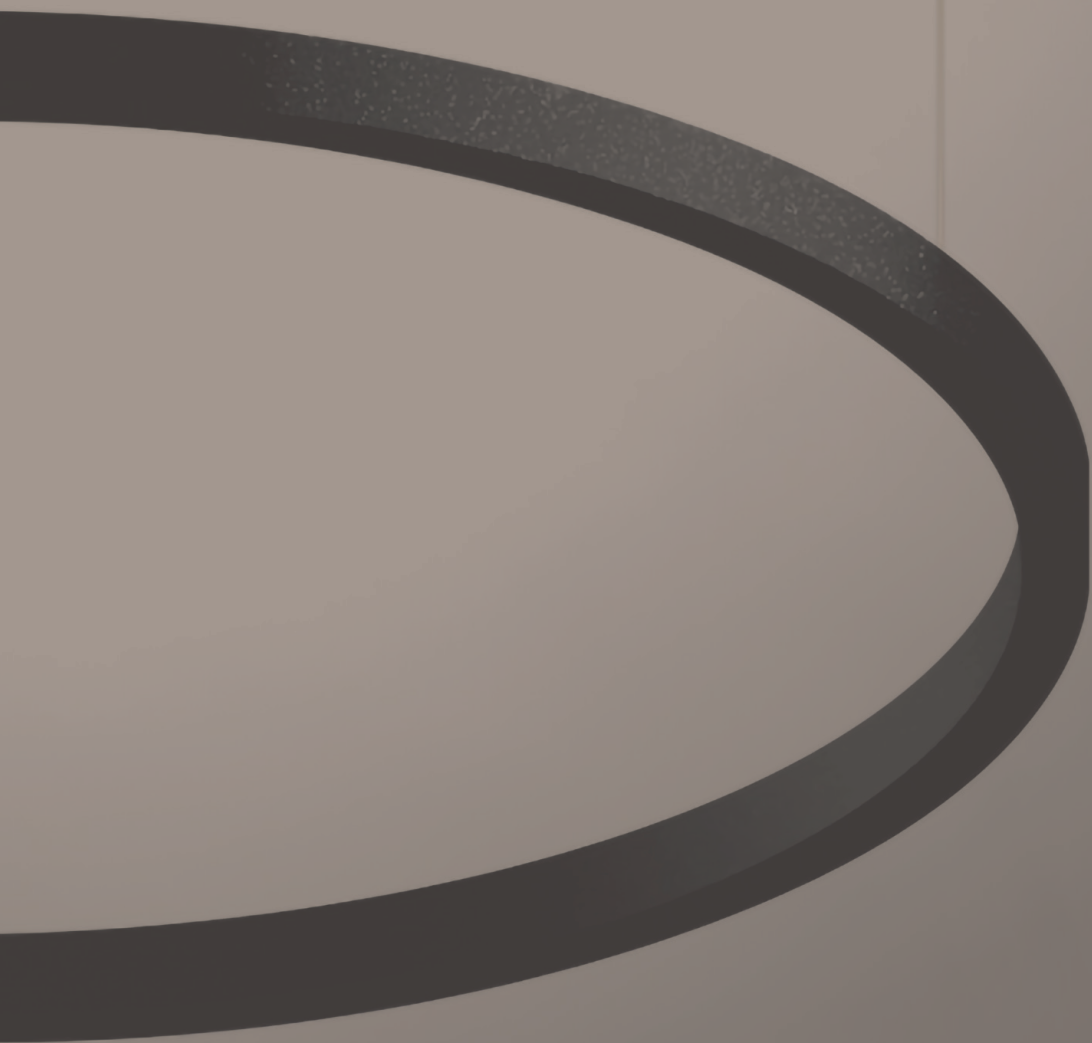

SOSPENSIONE
SUSPENSION LAMP
PEDELLEUCHTE





 **CODICE COMPLETO DEL PRODOTTO NELLA FOTO**
FULL PRODUCT CODE AS SHOWN IN PICTURE • VOLLSTÄNDIGER CODE VOM ARTIKEL IM BILD

1087BTF | **RV** | **E2** | **B**

Codice
Code

Finitura
Finishing
Lackierung

Diffusore
Diffuser
Diffusor

Tonalità
Hue
Farbton



configurazione standard: / basic configuration: / Standard Konfiguration:

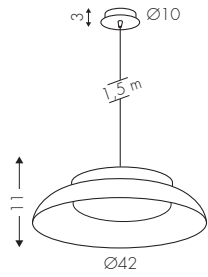

E2 Opale - Opal

● B 3000K

BV

1087BTFBVE2B

18W 1620lm* - 220V

430,00 €

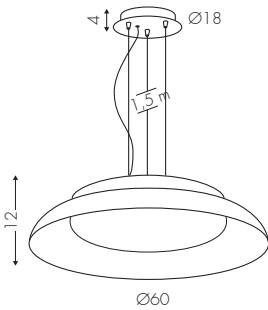

1087DTFBVE2B

30W 3000lm - 220V

560,00 €

Configura

Configure / Konfigurieren

www.teamitaliailluminazione.it

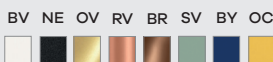
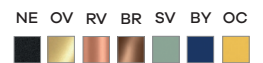

TF Taglio di Fase - Phase-Cut Dimmer - Phasenabschnittdimmer

A Alimentatore Incorporato - Incorporated Power Supply - Eingebautes Netzteil

* 1620lm effettivi - effective - effektiven con - with - mit **E2**

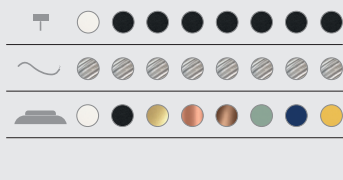



 **CODICE COMPLETO DEL PRODOTTO NELLA FOTO**
FULL PRODUCT CODE AS SHOWN IN PICTURE • VOLLSTÄNDIGER CODE VOM ARTIKEL IM BILD

1037SOF | **NE** | **E19** | **B**

Codice
Code

Finitura
Finishing
Lackierung

Diffusore
Diffuser
Diffusor

Tonalità
Hue
Farbton



EMME 24

SOSPENSIONE (composizione)
SUSPENSION (composition)
SUSPENSION (composition)



configurazione standard: / basic configuration: / Standard Konfiguration:

BV

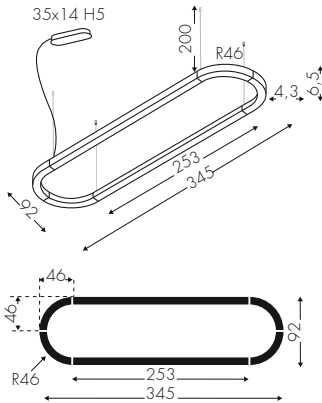

E2 Opale - Opal

B 3000K

1037SOFBVE2B

184W 13540lm* - 220V

2.145,00 €

1037SDMBVE2B

DALI (Push) - 184W 13540lm - 220V

2.232,00 €

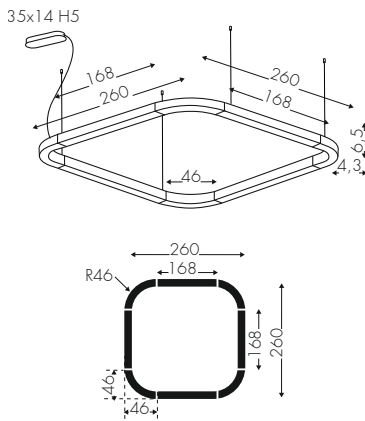

1037TOFBVE2B

220W 16355lm - 220V

2.565,00 €

1037TDMBVE2B

DALI (Push) - 220W 16355lm - 220V

2.652,00 €

Configura

Configure / Konfigurieren

www.teamitaliailluminazione.it



A

E19 UGR<19 Prism



C 4000K

NE



BV NE

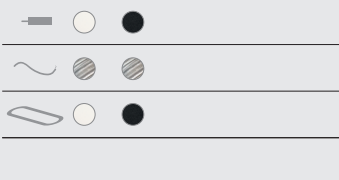

A Alimentatore nel rosone - Power Supply inside the ceiling rose - Netzteil in der Deckendose

* 13540lm effettivi - effective - effektive con - with - mit E2

15920lm effettivi - effective - effektive con - with - mit E19 +17,5%



 **CODICE COMPLETO DEL PRODOTTO NELLA FOTO**
FULL PRODUCT CODE AS SHOWN IN PICTURE • VOLLSTÄNDIGER CODE VOM ARTIKEL IM BILD

1083GTF **OV** **E2** **B**

Codice
Code

Finitura
Finishing
Lackierung

Diffusore
Diffuser
Diffusor

Tonalità
Hue
Farbton



configurazione standard: / basic configuration: / Standard Konfiguration:

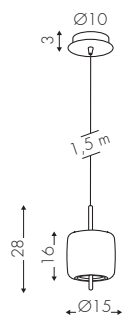

E2 Opale - Opal - Opal

● B 3000K



1083ATFBVE2B

6,5W 900lm* - 220V

370,00 €

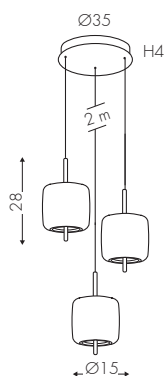

1083GTFBVE2B

3x6,5W 3x900lm - 220V

835,00 €

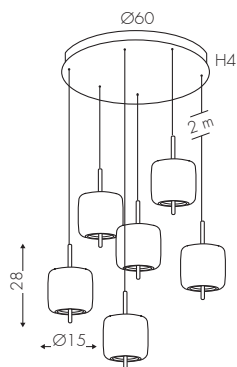

1083HTFBVE2B

6x6,5W 6x900lm - 220V

2.050,00 €

● C005T2NE

Custom black cable

8,00 € /MT

Configura

Configure / Konfigurieren

www.teamitaliailluminazione.it



A

● A 2700K

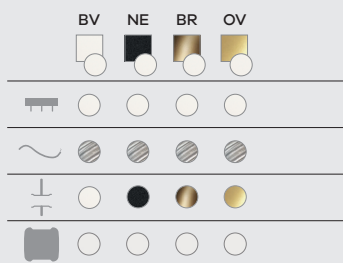

TF Taglio di Fase - Phase-Cut Dimmer - Phasenabschrittdimmer

A Alimentatore nel rosone - Power Supply inside the ceiling rose - Netzteil in der Deckendose

* 900lm effettivi - effective - effektive con - with - mit **E2**



BF custom finish



 **CODICE COMPLETO DEL PRODOTTO NELLA FOTO**
FULL PRODUCT CODE AS SHOWN IN PICTURE • VOLLSTÄNDIGER CODE VOM ARTIKEL IM BILD

1082HTF | **BF** | **E2** | **A**

Codice
Code

Finitura
Finishing
Lackierung

Diffusore
Diffuser
Diffusor

Tonalità
Hue
Farbton



configurazione standard: / basic configuration: / Standard Konfiguration:

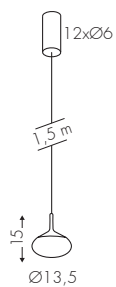

E2 Opale - Opal - Opal

● B 3000K



1082ATFBVE2B

6,5W 680lm* - 220V

310,00 €

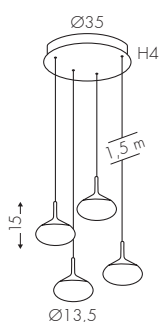

1082GTFBVE2B

4x6,5W 4x680lm - 220V

980,00 €

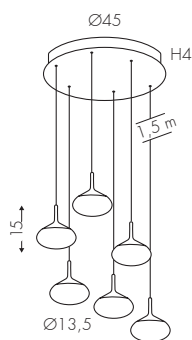

1082HTFBVE2B

6x6,5W 6x800lm - 220V

1.750,00 €

● **C005T2NE**

Custom black cable

8,00 € /MT

Configura

Configure / Konfigurieren

www.teamitaliailluminazione.it



A

● A 2700K



TF Taglio di Fase - Phase-Cut Dimmer - Phasenabschrittdimmer

A Alimentatore nel rosone - Power Supply inside the ceiling rose - Netzteil in der Deckendose

* 680lm effettivi - effective - effektive con - with - mit **E2**



RU custom finish



 CODICE COMPLETO DEL PRODOTTO NELLA FOTO
FULL PRODUCT CODE AS SHOWN IN PICTURE • VOLLSTÄNDIGER CODE VOM ARTIKEL IM BILD

1082ITF | **RU** | **E2** | **A**

Codice
Code

Finitura
Finishing
Lackierung

Diffusore
Diffuser
Diffusor

Tonalità
Hue
Farbton



configurazione standard: / basic configuration: / Standard Konfiguration:

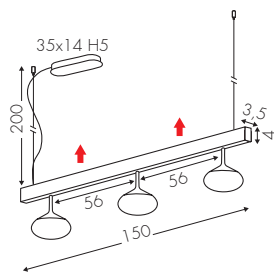

E2 Opale - Opal - Opal

B 3000K

BV



1082LTFBVE2B

3x6,5W 3x680lm - 220V + up 22W 1890lm

790,00 €

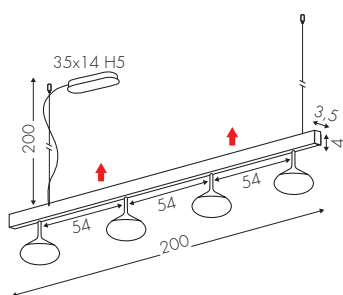

1082ITFBVE2B

4x6,5W 4x680lm* - 220V + up 33W 2830lm

1.100,00 €

Configura

Configure / Konfigurieren

www.teamitaliailluminazione.it



A 2700K



TF Taglio di Fase - Phase-Cut Dimmer - Phasenabschnittdimmer

A Alimentatore nel rosone - Power Supply inside the ceiling rose - Netzteil in der Deckendose

* 680lm effettivi - effective - effektive con - with - mit **E2**



 CODICE COMPLETO DEL PRODOTTO NELLA FOTO
FULL PRODUCT CODE AS SHOWN IN PICTURE • VOLLSTÄNDIGER CODE VOM ARTIKEL IM BILD

1065D

Codice
Code

NE

Finitura
Finishing
Lackierung

E2

Diffusore
Diffuser
Diffusor

B

Tonalità
Hue
Farbton





configurazione standard: / basic configuration: / Standard Konfiguration:

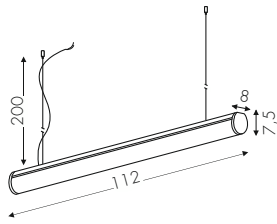

E2 Opale - Opal - Opal

B 3000K

BV

1065BBVE2B

25W 2856lm* - 24VDC

242,00 €

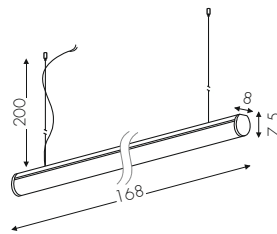

1065DBVE2B

37W 4290lm - 24VDC

276,00 €

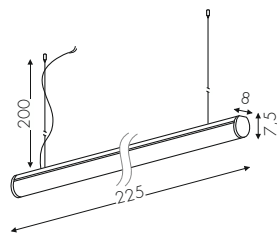

1065FBVE2B

50W 5738lm - 24VDC

321,00 €

Configura

Configure / Konfigurieren

www.teamitaliailluminazione.it



A 2700K C 4000K

NE

BV NE

Alimentatore 24VDC non incluso - Not Included 24VDC Driver
24VDC Netzteil nicht im Lieferumfang enthalten

Alimentatori a pag.132 - Power Supply p.132 - Netzteil p.132

* 2856lm effettivi - effective - effektive con - with - mit E2

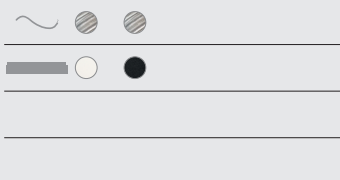



6500K

2700K

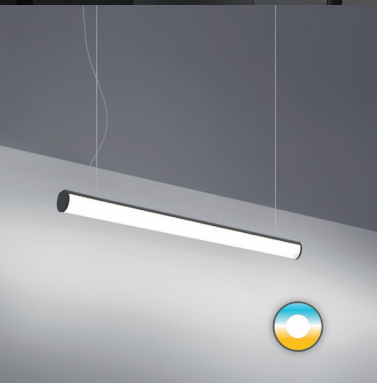

 **CODICE COMPLETO DEL PRODOTTO NELLA FOTO**
FULL PRODUCT CODE AS SHOWN IN PICTURE • VOLLSTÄNDIGER CODE VOM ARTIKEL IM BILD

1065TWB

Codice
Code

BV

Finitura
Finishing
Lackierung

E2

Diffusore
Diffuser
Diffusor

D

Tonalità
Hue
Farbton



configurazione standard: / basic configuration: / Standard Konfiguration:

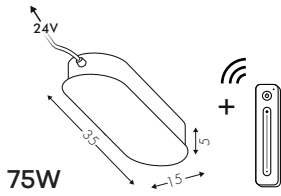

75W

9065TWA^{SDBV}

75W - 220V (24VDC) + SMART DIM Tunable White

212,00 €

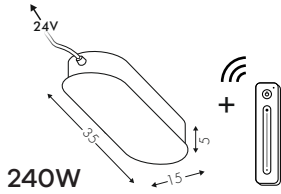

240W

9065TWC^{SDBV}

240W - 220V (24VDC) + SMART DIM Tunable White

307,00 €

Configura



Configure / Konfigurieren

www.teamitaliailluminazione.it



configurazione standard: / basic configuration: / Standard Konfiguration:

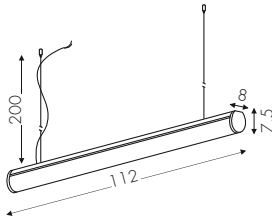

E2 Opale - Opal - Opal

D 2700/6500K

1065TWBBVE2D

32W 3600lm* - 24VDC

279,00 €

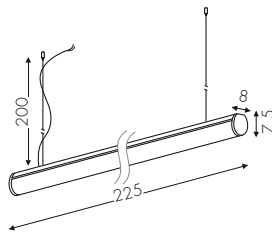

1065TWFBVE2D

60W 6750lm - 24VDC

370,00 €

Configura



Configure / Konfigurieren

www.teamitaliailluminazione.it

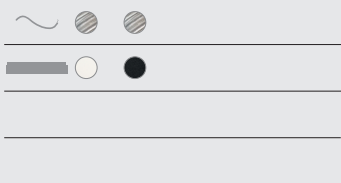

Alimentatore 24VDC non incluso - Not Included 24VDC Driver
24VDC Netzteil nicht im Lieferumfang enthalten

Alimentatori a pag.132 - Drivers p.132 - Netzteil p.132

Alimentatore Incorporato - Incorporated Power Supply - Eingebautes Netzteil

* 3600lm effettivi - effective - effektive con - with - mit E2



 **CODICE COMPLETO DEL PRODOTTO NELLA FOTO**
FULL PRODUCT CODE AS SHOWN IN PICTURE • VOLLSTÄNDIGER CODE VOM ARTIKEL IM BILD

1015MTF

Codice
Code

OV

Finitura
Finishing
Lackierung

E2

Diffusore
Diffuser
Diffusor

B

Tonalità
Hue
Farbton



OVERLAP DECÒ

SOSPENSIONE
SUSPENSION LAMP
PENDELLEUCHE



configurazione standard: / basic configuration: / Standard Konfiguration:

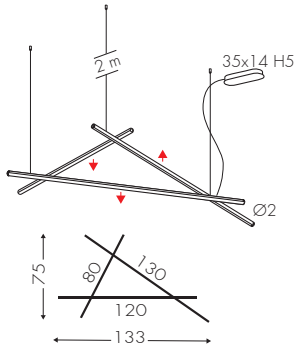

E2 Opale - Opal

B 3000K



1015GTFBVE2B

75W 5500lm* - 220V

780,00 €

1015GDMBVE2B

DALI (Push) - 75W 5500lm - 220V

860,00 €

1015GSDBVE2B

75W 5500lm - 220V

860,00 €

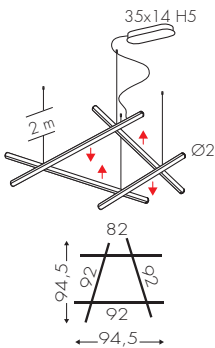

1015LTFBVE2B

78W 6000lm - 220V

780,00 €

1015LDMBVE2B

DALI (Push) - 78W 6000lm - 220V

860,00 €

1015LSDBVE2B

78W 6000lm - 220V

860,00 €

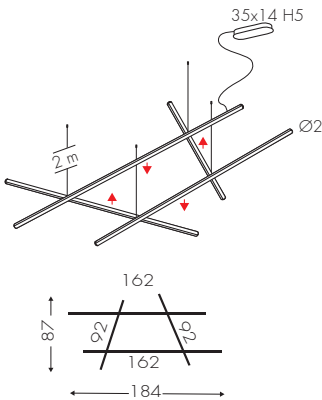

1015MTFBVE2B

110W 8500lm - 220V

890,00 €

1015MDMBVE2B

DALI (Push) - 110W 8500lm - 220V

970,00 €

1015MSDBVE2B

110W 8500lm - 220V

970,00 €

C005T2NE

Custom black cable

8,00 € /MT

Configura



Configure / Konfigurieren

www.teamitaliailluminazione.it



A

A 2700K



BV NE RU OV BR RV

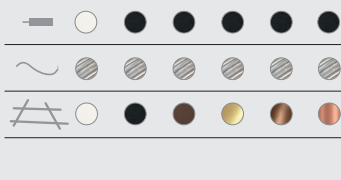

A Alimentatore nel rosone - Power Supply inside the ceiling rose - Netzteil in der Deckendose

TF Taglio di Fase - Phase-Cut Dimmer - Phasenabschrittdimmer

SD Telecomando radio - Smart Dimmer - Smart Dimmer



* 5500lm effettivi - effective - effektiven con - with - mit **E2**



 **CODICE COMPLETO DEL PRODOTTO NELLA FOTO**
FULL PRODUCT CODE AS SHOWN IN PICTURE • VOLLSTÄNDIGER CODE VOM ARTIKEL IM BILD

1067DOF | **NE** | **E2** | **B**

Codice
Code

Finitura
Finishing
Lackierung

Diffusore
Diffuser
Diffusor

Tonalità
Hue
Farbton



configurazione standard: / basic configuration: / Standard Konfiguration:

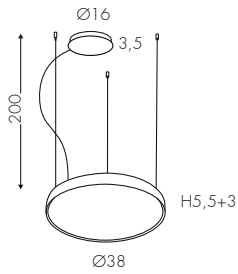

E2 Opale - Opal

● B 3000K

BV

1067BOFBVE2B

26W 3586lm* - 220V

490,00 €

1067BDMBVE2B

DALI (Push) - 26W 3586lm - 220V

610,00 €

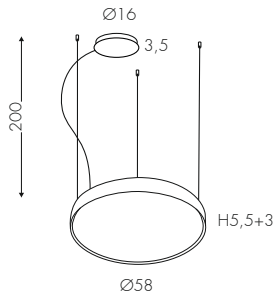

1067DOFBVE2B

47W 6500lm - 220V

675,00 €

1067DDMBVE2B

DALI (Push) - 47W 6500lm - 220V

775,00 €

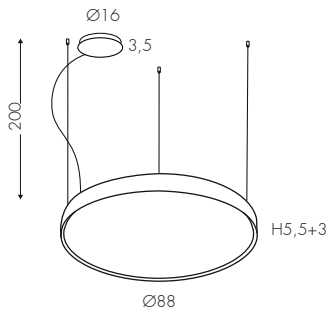

1067FOFBVE2B

70W 8220lm - 220V

970,00 €

1067FDMBVE2B

DALI (Push) - 70W 8220lm - 220V

1.070,00 €

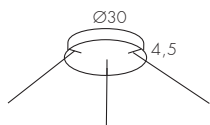

VA003E

Variation: sostituzione con rosone centrale Ø30cm
Variation: substitution with central ceiling rose Ø30cm
Variante: Ersatz durch zentrale Deckenrose Ø30cm

100,00 €

Configura

Configure / Konfigurieren

www.teamitaliailluminazione.it



E19 UGR<19 Prism

○ C 4000K

NE

BV NE

A Alimentatore Incorporato - Incorporated Power Supply - Eingebautes Netzteil

* 3586lm effettivi - effective - effektive con - with - mit E2
4220lm effettivi - effective - effektive con - with - mit E19 ↻ +17,5%





 **CODICE COMPLETO DEL PRODOTTO NELLA FOTO**
FULL PRODUCT CODE AS SHOWN IN PICTURE • VOLLSTÄNDIGER CODE VOM ARTIKEL IM BILD

1068DITF | **OV** | **E2** | **B**

Codice
Code

Finitura
Finishing
Lackierung

Diffusore
Diffuser
Diffusor

Tonalità
Hue
Farbton



configurazione standard: / basic configuration: / Standard Konfiguration:

BV



E2 Opale - Opal - Opal

● B 3000K

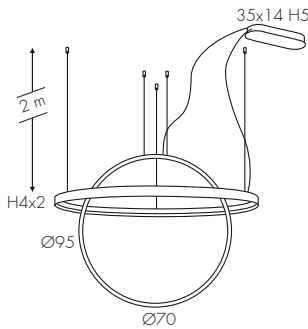

1068CHTFBVE2B

66W 5630lm* + 49W 3440lm 220V

1.200,00 €

1068CHDMBVE2B

DALI (Push) - 66W 5630lm + 49W 3440lm 220V

1.370,00 €

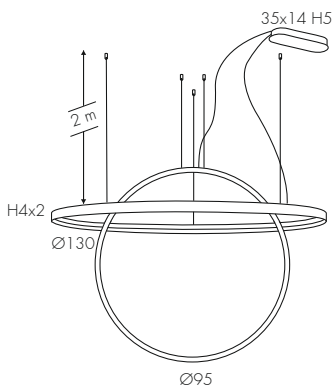

1068DITFBVE2B

90W 7750lm + 66W 3680lm 220V

1.442,00 €

1068DIDMBVE2B

DALI (Push) - 90W 7750lm + 66W 3680lm 220V

1.635,00 €

● C005T2NE

Custom black cable

8,00 € /MT

Configura

Configure / Konfigurieren

www.teamitaliailluminazione.it



A

● A 2700K

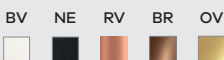

A Alimentatore nel rosone - Power Supply inside the ceiling rose - Netzteil in der Deckendose

TF Taglio di Fase - Phase-Cut Dimmer - Phasenabschnittdimmer

* 5630lm effettivi - effective - effektive con - with - mit **E2**

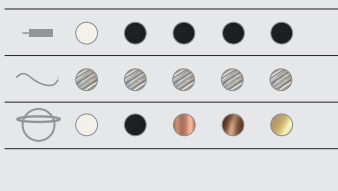



optional

E19

↑ CODICE COMPLETO DEL PRODOTTO NELLA FOTO
FULL PRODUCT CODE AS SHOWN IN PICTURE • VOLLSTÄNDIGER CODE VOM ARTIKEL IM BILD

1069MTF | **PN** | **E8** | **B**

Codice
Code

Finitura
Finishing
Lackierung

Diffusore
Diffuser
Diffusor

Tonalità
Hue
Farbton



standard



E8

CODICE COMPLETO • COMPLETE CODE • VOLLSTÄNDIGE CODE

1069TF | **ON** | **E8** | **B**

Codice
Code

Finitura
Finishing
Lackierung

Diffusore
Diffuser
Diffusor

Tonalità
Hue
Farbton

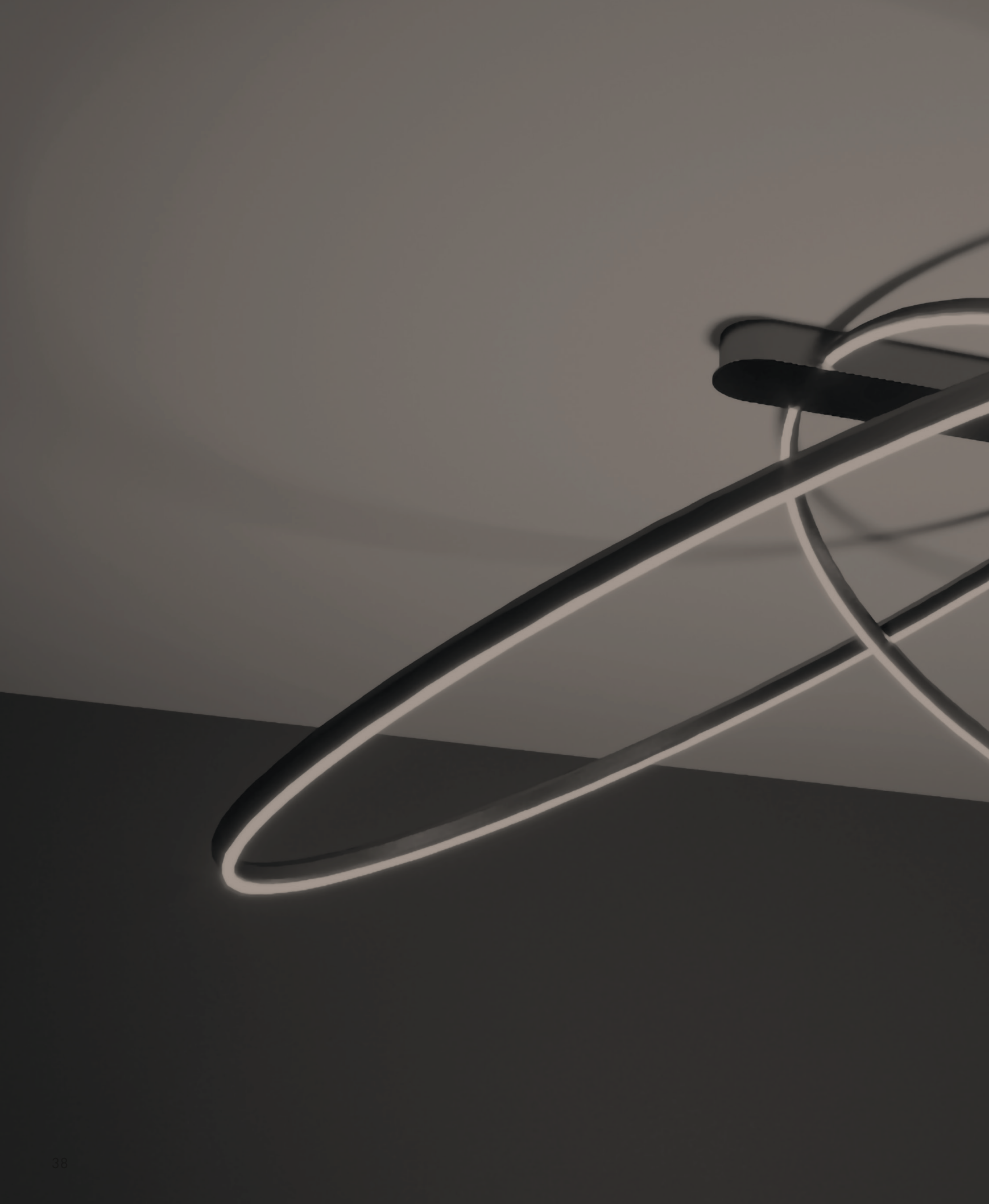

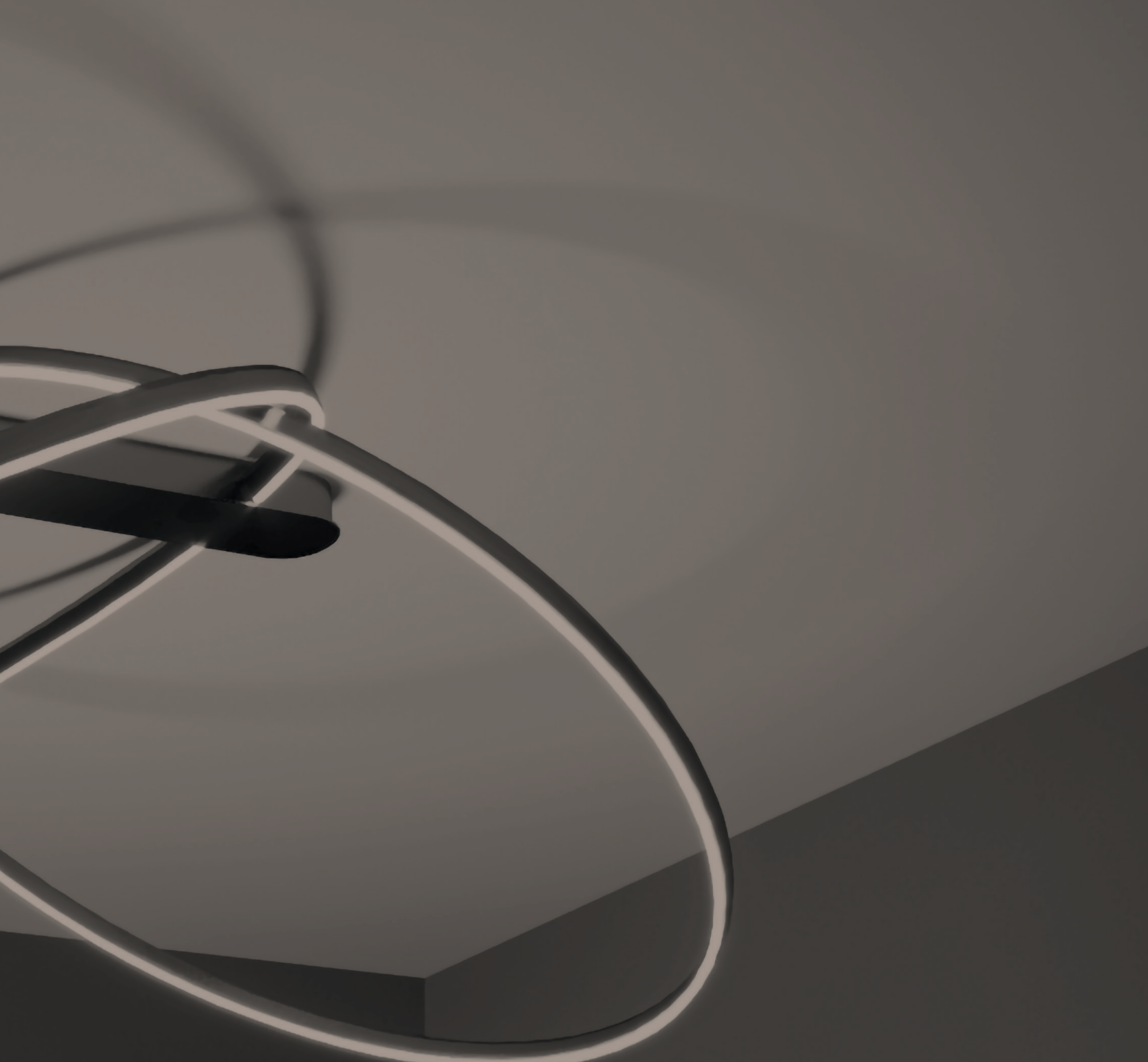

**PLAFONE
CEILING LIGHT
DECKENLEUCHTE**





 **CODICE COMPLETO DEL PRODOTTO NELLA FOTO**
FULL PRODUCT CODE AS SHOWN IN PICTURE • VOLLSTÄNDIGER CODE VOM ARTIKEL IM BILD

3087DTF | **OV** | **E2** | **B**

Codice
Code

Finitura
Finishing
Lackierung

Diffusore
Diffuser
Diffusor

Tonalità
Hue
Farbton





configurazione standard: / basic configuration: / Standard Konfiguration:

E2 Opale - Opal

 B 3000K

BV

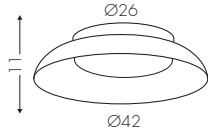

3087BTFBVE2B

18W 1620lm* - 220V

370,00 €

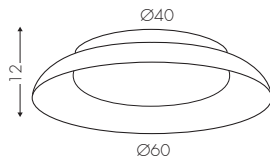

3087DTFBVE2B

30W 3000lm - 220V

495,00 €

Configura 

Configure / Konfigurieren

www.teamitaliailluminazione.it

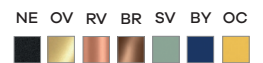

TF Taglio di Fase - Phase-Cut Dimmer - Phasenabschnittdimmer

A Alimentatore Incorporato - Incorporated Power Supply - Eingebautes Netzteil

* 1620lm effettivi - effective - effektiven con - with - mit **E2**



 **CODICE COMPLETO DEL PRODOTTO NELLA FOTO**
FULL PRODUCT CODE AS SHOWN IN PICTURE • VOLLSTÄNDIGER CODE VOM ARTIKEL IM BILD

3080DOF **BV** **E2** **B**

Codice
Code

Finitura
Finishing
Lackierung

Diffusore
Diffuser
Diffusor

Tonalità
Hue
Farbton



configurazione standard: / basic configuration: / Standard Konfiguration:

E2 Opale - Opal

 B 3000K

BV

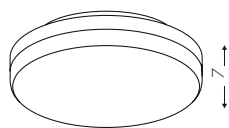

Ø25

3080BOFBVE2B

12W 1300lm* - 220V

78,00 €

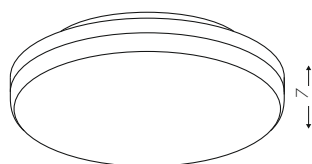

Ø40

3080DOFBVE2B

30W 3000lm - 220V

148,00 €

Configura 

Configure / Konfigurieren

www.teamitaliailluminazione.it



BV



A Alimentatore Incorporato - Incorporated Power Supply - Eingebautes Netzteil

* 1300lm effettivi - effective - effektiven con - with - mit **E2**



 **CODICE COMPLETO DEL PRODOTTO NELLA FOTO**
FULL PRODUCT CODE AS SHOWN IN PICTURE • VOLLSTÄNDIGER CODE VOM ARTIKEL IM BILD

3076CTF **ZN** **E2** **A**

Codice
Code

Finitura
Finishing
Lackierung

Diffusore
Diffuser
Diffusor

Tonalità
Hue
Farbton



configurazione standard: / basic configuration: / Standard Konfiguration:

E2 Opale - Opal

B 3000K

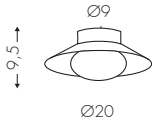

3076ATFNREE2B

10W 650lm* - 220V

198,00 €

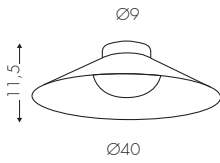

3076CTFNREE2B

17W 1100lm - 220V

315,00 €

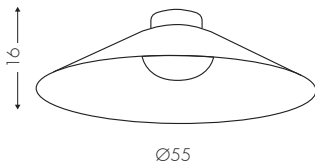

3076DTFNREE2B

17W 1100lm - 220V

368,00 €

Configura

Configure / Konfigurieren

www.teamitaliailluminazione.it



A 2700K

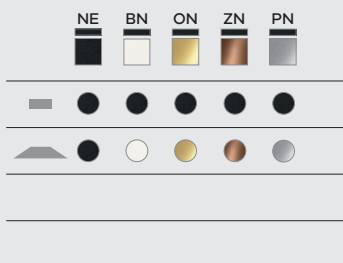

TF Taglio di Fase - Phase-Cut Dimmer - Phasenabschnittdimmer

A Alimentatore Incorporato - Incorporated Power Supply - Eingebautes Netzteil

* 650lm effettivi - effective - effektiven con - with - mit **E2**



 **CODICE COMPLETO DEL PRODOTTO NELLA FOTO**
FULL PRODUCT CODE AS SHOWN IN PICTURE • VOLLSTÄNDIGER CODE VOM ARTIKEL IM BILD

3094AOF **BN** **E24** **B**

Codice
Code

Finitura
Finishing
Lackierung

Diffusore
Diffuser
Diffusor

Tonalità
Hue
Farbton



configurazione standard: / basic configuration: / Standard Konfiguration:

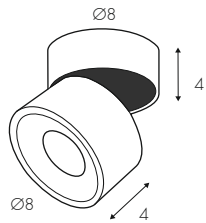

24° Ottica - Optic - Optik

● B 3000K

BV



3094AOFBV24B

1x10W 1100lm* - 220V

145,00 €

Configura 

Configure / Konfigurieren

www.teamitaliailluminazione.it



TF Taglio di Fase - Phase-Cut Dimmer - Phasenabschnittdimmer

A Alimentatore Incorporato - Incorporated Power Supply - Eingebautes Netzteil

* 1100lm effettivi - effective - effektiven con - with - mit **E2**



 **CODICE COMPLETO DEL PRODOTTO NELLA FOTO**
FULL PRODUCT CODE AS SHOWN IN PICTURE • VOLLSTÄNDIGER CODE VOM ARTIKEL IM BILD

30090TF | **NE** | **E28** | **B**

Codice
Code

Finitura
Finishing
Lackierung

Diffusore
Diffuser
Diffusor

Tonalità
Hue
Farbton



configurazione standard: / basic configuration: / Standard Konfiguration:

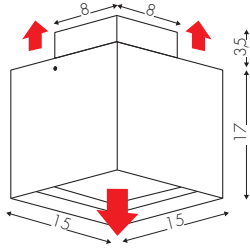

E28 Satinato
Frosted - Satiniert

B 3000K

BV

30090TFBVE28B

20W 1700lm* + 8W 950lm - 220V

286,00 €

Configura

Configure / Konfigurieren

www.teamitaliailluminazione.it



A

A 2700K **C** 4000K

NE RU

TF Taglio di Fase - Phase-Cut Dimmer - Erhältlich Phasenabschnittdimmer

A Alimentatore Incorporato - Incorporated Power Supply - Eingebautes Netzteil

* 1700lm effettivi - effective - effektive con - with - mit **E28**



 **CODICE COMPLETO DEL PRODOTTO NELLA FOTO**
FULL PRODUCT CODE AS SHOWN IN PICTURE • VOLLSTÄNDIGER CODE VOM ARTIKEL IM BILD

3015OTF | **BR** | **E2** | **B**

Codice
Code

Finitura
Finishing
Lackierung

Diffusore
Diffuser
Diffusor

Tonalità
Hue
Farbton

OVERLAP DECÒ

PLAFONE
CEILING LIGHT
DECKENLEUCHE



configurazione standard: / basic configuration: / Standard Konfiguration:

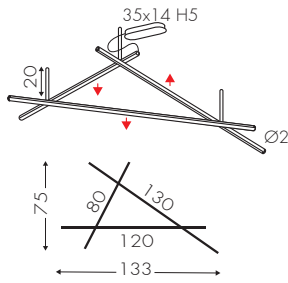

E2 Opale - Opal

B 3000K

BV

3015QTFBVE2B

75W 5500lm* - 220V

780,00 €

3015QDMBVE2B

DALI (Push) - 75W 5500lm - 220V

860,00 €

3015QSDBVE2B

75W 5500lm - 220V

860,00 €

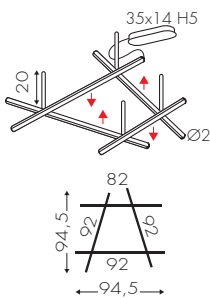

3015OTFBVE2B

78W 6000lm - 220V

780,00 €

3015ODMBVE2B

DALI (Push) - 78W 6000lm - 220V

860,00 €

3015OSDBVE2B

78W 6000lm - 220V

860,00 €

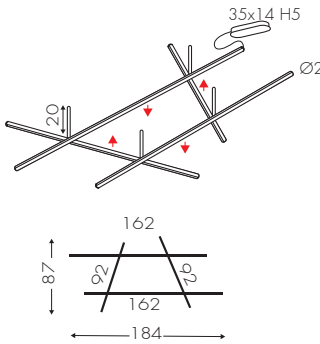

3015PTFBVE2B

110W 8500lm - 220V

890,00 €

3015PDMBVE2B

DALI (Push) - 110W 8500lm - 220V

970,00 €

3015PSDBVE2B

110W 8500lm - 220V

970,00 €

Configura

Configure / Konfigurieren

www.teamitaliailluminazione.it



A

A 2700K



A Alimentatore nel rosone - Power Supply inside the ceiling rose - Netzteil in der Deckendose

TF Taglio di Fase - Phase-Cut Dimmer - Phasenabschnittdimmer

SD Telecomando radio - Smart Dimmer - Smart Dimmer

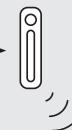

* 5500lm effettivi - effective - effektiven con - with - mit **E2**



 **CODICE COMPLETO DEL PRODOTTO NELLA FOTO**
FULL PRODUCT CODE AS SHOWN IN PICTURE • VOLLSTÄNDIGER CODE VOM ARTIKEL IM BILD

3067BOF | **NE** | **E2** | **B**

Codice
Code

Finitura
Finishing
Lackierung

Diffusore
Diffuser
Diffusor

Tonalità
Hue
Farbton



configurazione standard: / basic configuration: / Standard Konfiguration:

E2 Opale - Opal

B 3000K

BV

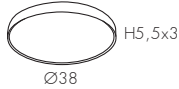

3067BOFBVE2B
3067BDMBVE2B

26W 3586lm* - 220V
DALI (Push) - 26W 3586lm - 220V

410,00 €
530,00 €

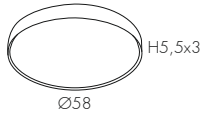

3067DOFBVE2B
3067DDMBVE2B

47W 6500lm - 220V
DALI (Push) - 47W 6500lm - 220V

595,00 €
695,00 €

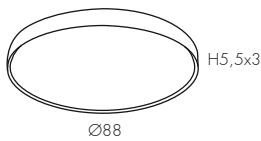

3067FOFBVE2B
3067FDMBVE2B

70W 8220lm - 220V
DALI (Push) - 70W 8220lm - 220V

890,00 €
990,00 €

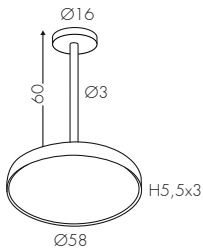

3067QOFBVE2B
3067QDMBVE2B

26W 3586lm - 220V
DALI (Push) - 26W 3586lm - 220V

675,00 €
775,00 €

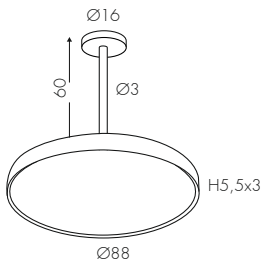

3067ROFBVE2B
3067RDMBVE2B

47W 6500lm - 220V
DALI (Push) - 47W 6500lm - 220V

970,00 €
1.070,00 €

Configura

Configure / Konfigurieren

www.teamitaliailluminazione.it



E19 UGR<19 Prism

C 4000K

NE

A Alimentatore Incorporato - Incorporated Power Supply - Eingebautes Netzteil

* 3586lm effettivi - effective - effektive con - with - mit E2
4220lm effettivi - effective - effektive con - with - mit E19 +17,5%



PIANTANA
FLOOR LAMP
STEHLAMPE





 CODICE COMPLETO DEL PRODOTTO NELLA FOTO
FULL PRODUCT CODE AS SHOWN IN PICTURE • VOLLSTÄNDIGER CODE VOM ARTIKEL IM BILD

5028BDM | **NE** | **E19** | **B**

Codice
Code

Finitura
Finishing
Lackierung

Diffusore
Diffuser
Diffusor

Tonalità
Hue
Farbton



configurazione standard: / basic configuration: / Standard Konfiguration:

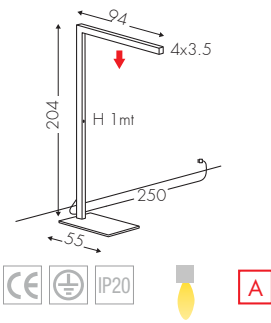

E19 UGR<19 Prism

B 3000K

BV

5028BDMBVE19B

DIM (Push) - 51W 4400lm* - 220V

925,00 €

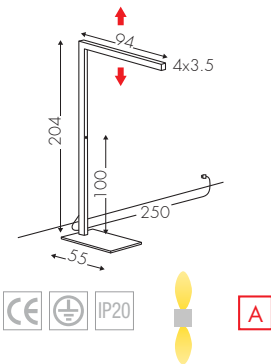

5028CDMBVE19B

DIM (Push) - down 51W 4400lm - up 20W 2200lm - 220V

955,00 €

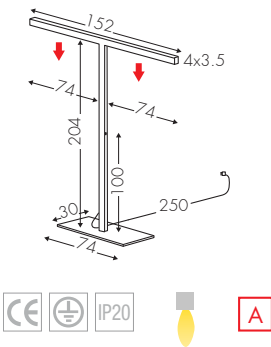

5028DDMBVE19B

DIM (Push) - down 2x32W 2x3500lm

1.530,00 €

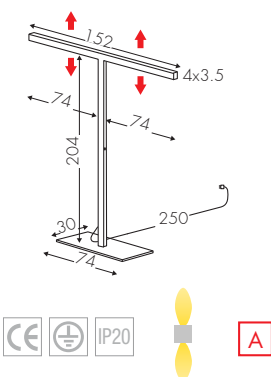

5028EDMBVE19B

DIM (Push) - down 2x32W 2x3500lm - up 2x12W 2x1200lm

1.730,00 €

Configura

Configure / Konfigurieren

www.teamitaliailluminazione.it



A 2700K C 4000K

NE RU

A Alimentatore Incorporato - Incorporated Power Supply - Eingebautes Netzteil

* 4400lm effettivi - effective - effektive con - with - mit **E19**



 **CODICE COMPLETO DEL PRODOTTO NELLA FOTO**
FULL PRODUCT CODE AS SHOWN IN PICTURE • VOLLSTÄNDIGER CODE VOM ARTIKEL IM BILD

5071EDP | **ZN** | **E2** | **B**

Codice
Code

Finitura
Finishing
Lackierung

Diffusore
Diffuser
Diffusor

Tonalità
Hue
Farbton



configurazione standard: / basic configuration: / Standard Konfiguration:

E2 Opale - Opal

B 3000K



5071EDPONE2B

35W 3800lm* - 220V

680,00 €

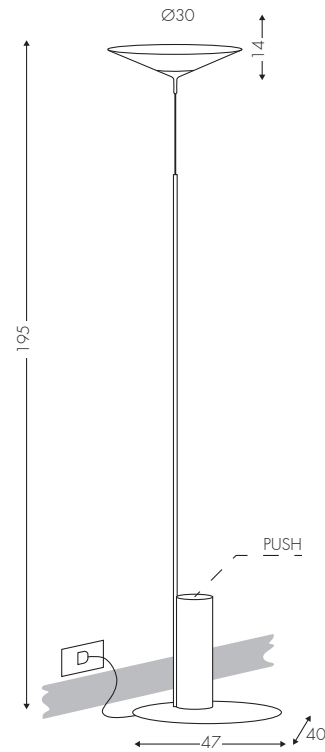

Configura

Configure / Konfigurieren

www.teamitaliailluminazione.it



A 2700K



A Alimentatore Incorporato - Incorporated Power Supply - Eingebautes Netzteil

DP Dim Push

* 3800lm effettivi - effective - effektive con - with - mit **E2**

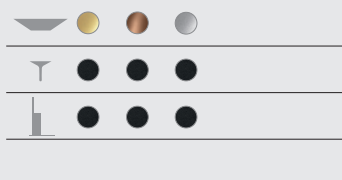



 **CODICE COMPLETO DEL PRODOTTO NELLA FOTO**
FULL PRODUCT CODE AS SHOWN IN PICTURE • VOLLSTÄNDIGER CODE VOM ARTIKEL IM BILD

5071CDP | **ON** | **E2** | **B**

Codice
Code

Finitura
Finishing
Lackierung

Diffusore
Diffuser
Diffusor

Tonalità
Hue
Farbton



configurazione standard: / basic configuration: / Standard Konfiguration:

E2 Opale - Opal

B 3000K



5071CDPONE2B

9W 1200lm* - 220V

818,00 €

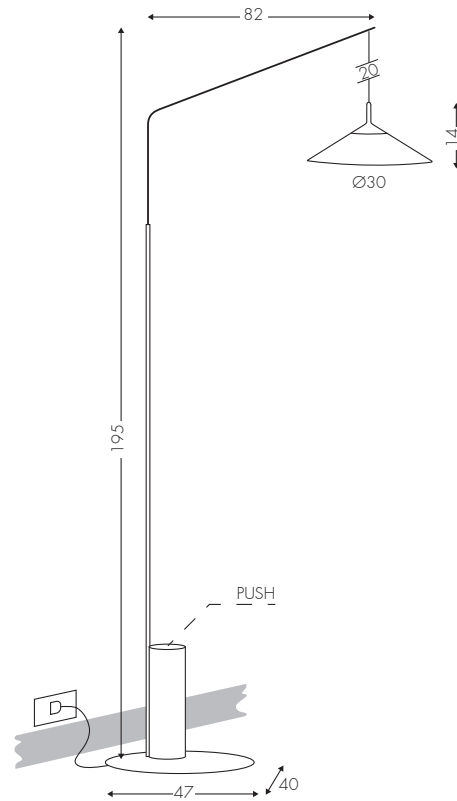

Configura

Configure / Konfigurieren

www.teamitaliailluminazione.it



A 2700K



A Alimentatore Incorporato - Incorporated Power Supply - Eingebautes Netzteil

DP Dim Push

* 1200lm effettivi - effective - effektive con - with - mit **E2**





 **CODICE COMPLETO DEL PRODOTTO NELLA FOTO**
FULL PRODUCT CODE AS SHOWN IN PICTURE • VOLLSTÄNDIGER CODE VOM ARTIKEL IM BILD

5071DDP | **PN** | **E2** | **B**

Codice
Code

Finitura
Finishing
Lackierung

Diffusore
Diffuser
Diffusor

Tonalità
Hue
Farbton



configurazione standard: / basic configuration: / Standard Konfiguration:

E2 Opale - Opal

B 3000K



5071DDPONE2B

9W 1200lm* - 220V

1.070,00 €

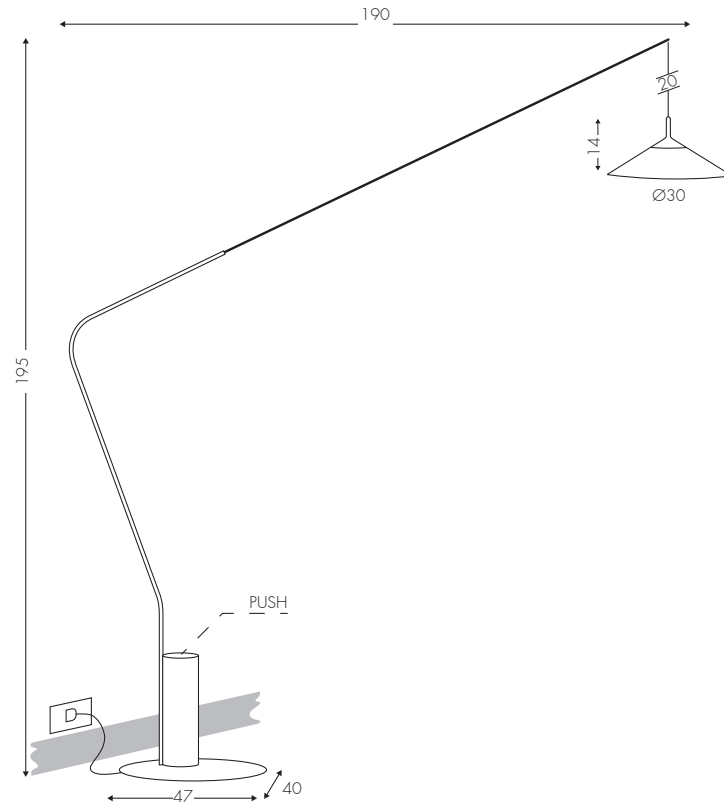

Configura

Configure / Konfigurieren

www.teamitaliailluminazione.it



A 2700K



A Alimentatore Incorporato - Incorporated Power Supply - Eingebautes Netzteil

DP Dim Push

* 1200lm effettivi - effective - effektive con - with - mit **E2**

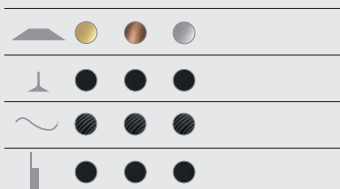

Incassi/recessed Einbauleuchte

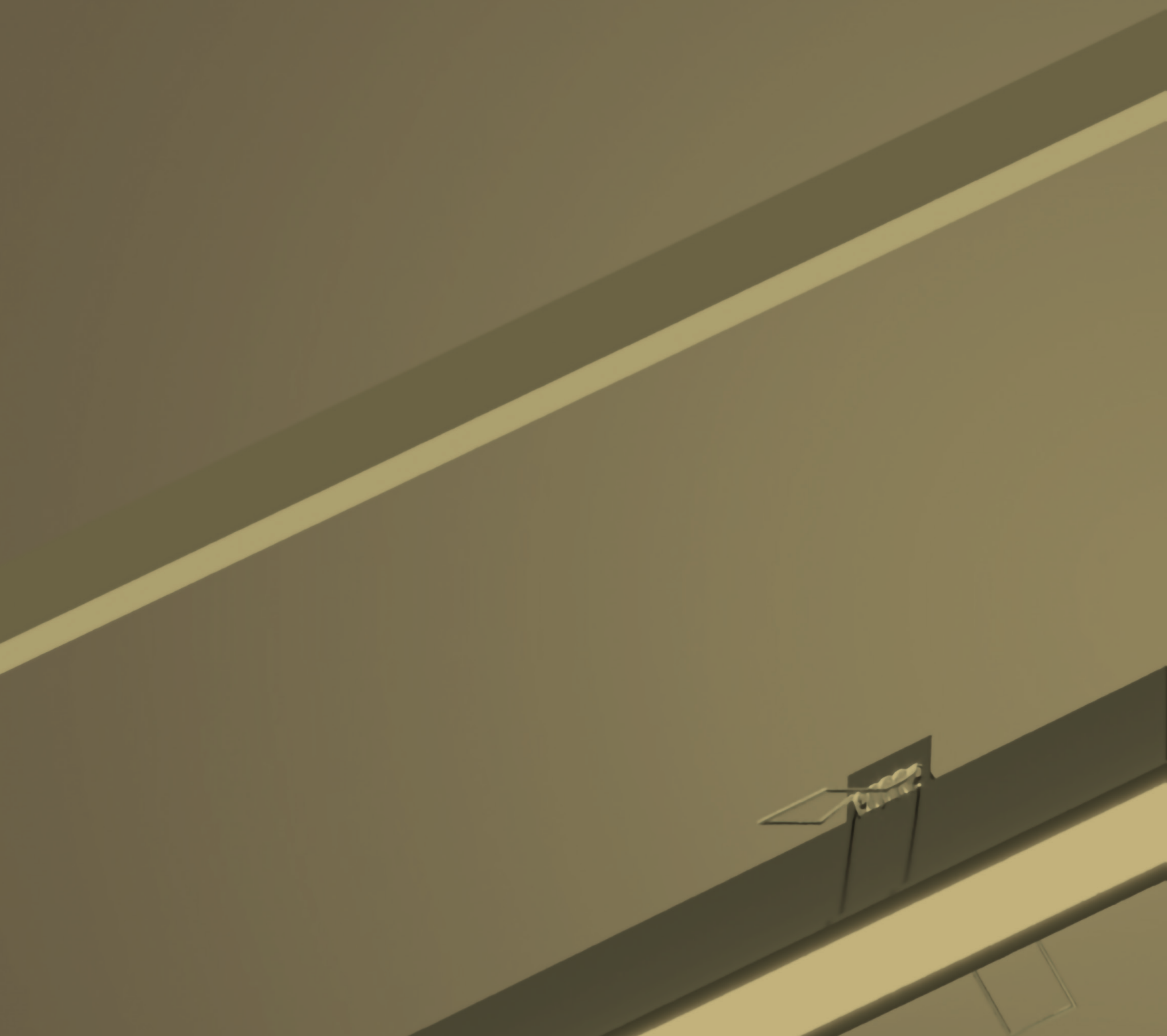





 **CODICE COMPLETO DEL PRODOTTO NELLA FOTO**
FULL PRODUCT CODE AS SHOWN IN PICTURE • VOLLSTÄNDIGER CODE VOM ARTIKEL IM BILD

4089COF

Codice
Code

BV

Finitura
Finishing
Lackierung

45

Diffusore
Diffuser
Diffusor

B

Tonallità
Hue
Farbton



configurazione standard: / basic configuration: / Standard Konfiguration:

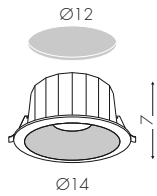

Ottica 45° (45)

B 3000K

BV

4089BOFBV45B

18W 1674lm* - 220V

53,00 €

4089BDMBV45B

DALI (Push) - 18W 1674lm - 220V

98,00 €

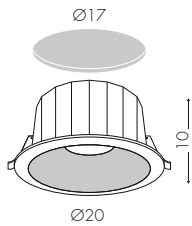

4089COFBV45B

36W 2800lm - 220V

99,00 €

4089CDMBV45B

DALI (Push) - 36W 2800lm - 220V

144,00 €

Configura

Configure / Konfigurieren

www.teamitaliailluminazione.it



C 4000K

BV

Alimentatore incluso in remoto - Included Power Supply in remote - Fernspeisung enthalten

* 1674lm effettivi - effective - effektive con - with - mit E2



 **CODICE COMPLETO DEL PRODOTTO NELLA FOTO**
FULL PRODUCT CODE AS SHOWN IN PICTURE • VOLLSTÄNDIGER CODE VOM ARTIKEL IM BILD

4094AOF **BN** **E24** **B**

Codice
Code

Finitura
Finishing
Lackierung

Diffusore
Diffuser
Diffusor

Tonalità
Hue
Farbton



configurazione standard: / basic configuration: / Standard Konfiguration:

24° Ottica - Optic - Optik

 B 3000K

BV

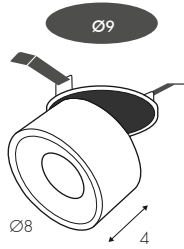

4094AOFBV24B

1x8W 900lm* - 220V

125,00 €

4094ADMBV24B

DALI (Push) - 1x8W 900lm - 220V

145,00 €

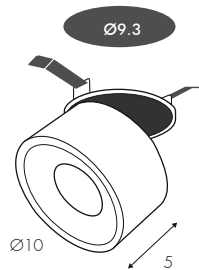

4094BOFBV24B

1x14W 1200lm - 220V

135,00 €

4094BDMBV24B

DALI (Push) - 1x14W 1200lm - 220V

155,00 €

Configura 

Configure / Konfigurieren

www.teamitaliailluminazione.it



TF Taglio di Fase - Phase-Cut Dimmer - Phasenabschrittdimmer

A Alimentatore Incorporato - Incorporated Power Supply - Eingebautes Netzteil

* 900lm effettivi - effective - effektiven con - with - mit **E2**

Profili/Profiles/Profile

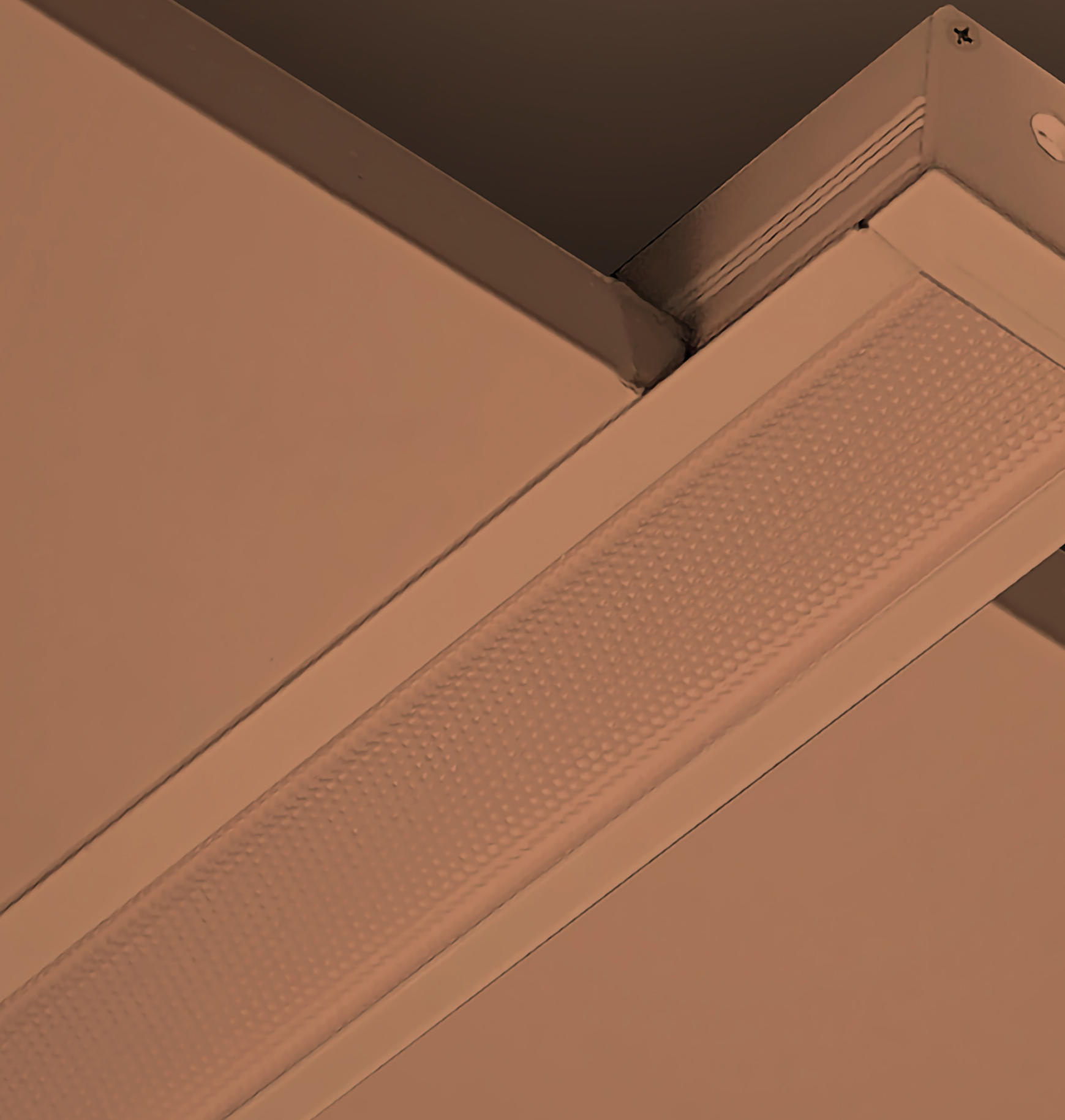





SV custom finish

CODICE COMPLETO · COMPLETE CODE · VOLLSTÄNDIGE CODE

3092ZOMT2 | **BV** | **E2** + | **001001A**

Codice
Code
Code

Finitura
Finishing
Lackierung

Diffusore
Diffuser
Diffusor

SERVICE



3092Z0 - PLAFONE MID

BV

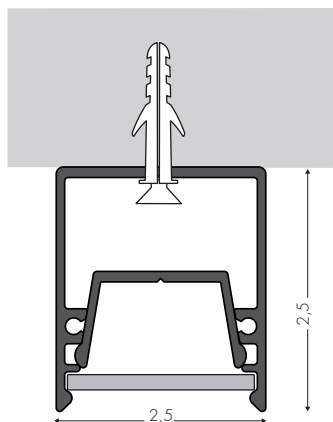

3092Z0MT1

profile 100 cm (NO LED)

60,00 €

3092Z0MT2

profile 200 cm (NO LED)

120,00 €

3092Z0MT3

profile 300 cm (NO LED)

170,00 €



E2 Opale - Opal



Led non incluso - Led not included - Led nicht inbegriffen



Alimentatore non incluso - Power Supply not included - Netzteil nicht inbegriffen

SERVIZIO SU MISURA

001001A

Taglio Profilo - Cut service

10,00 €

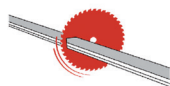

Outdoor





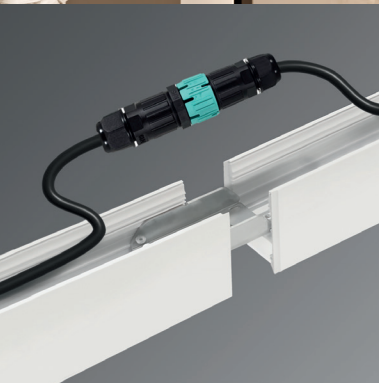

↑ CODICE COMPLETO DEL PRODOTTO NELLA FOTO
FULL PRODUCT CODE AS SHOWN IN PICTURE
VOLLSTÄNDIGER CODE VOM ARTIKEL IM BILD

1085EOF

Codice
Code

NE

Finitura
Finishing
Lackierung

E2

Diffusore
Diffuser
Diffusor

B

Tonalità
Hue
Farbton

MIRÓ IP54 DOWNLIGHT (1-10mt)

SOSPENSIONE
SUSPENSION LAMP
PENDELLEUCHE



configurazione standard: / basic configuration: / Standard Konfiguration:

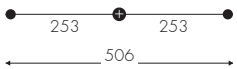
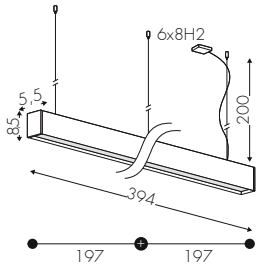
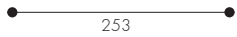
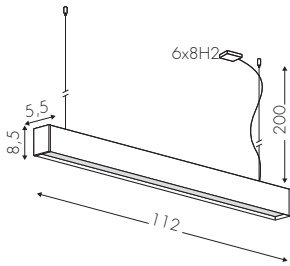

E2 Opale - Opal

B 3000K

BV

1085BOFBVE2B
1085BDMBVE2B

25W 1910lm* - 220V
DALI (Push) - 25W 1910lm - 220V

357,00 €
413,00 €

1085EOFBVE2B
1085EDMBVE2B

44W 3350lm - 220V
DALI (Push) - 44W 3350lm - 220V

461,00 €
522,00 €

1085GOFBVE2B
1085GDMBVE2B

56W 4305lm - 220V
DALI (Push) - 56W 4305lm - 220V

569,00 €
616,00 €

1085LOFBVE2B
1085LDMBVE2B

87W 6705lm - 220V
DALI (Push) - 87W 6705lm - 220V

1.001,00 €
1.150,00 €

1085MOFBVE2B
1085MDMBVE2B

111W 8605lm - 220V
DALI (Push) - 111W 8605m - 220V

1.174,00 €
1.291,00 €

1085ROFBVE2B
1085RDMBVE2B

223W 17210lm - 220V
DALI (Push) - 223W 17210lm - 220V

2.593,00 €
2.848,00 €

Configura

Configure / Konfigurieren

www.teamitaliailluminazione.it



C 4000K

NE

BV NE

A Alimentatore Incorporato - Incorporated Power Supply - Eingebautes Netzteil

* 1910lm effettivi - effective - effektive con - with - mit **E2**

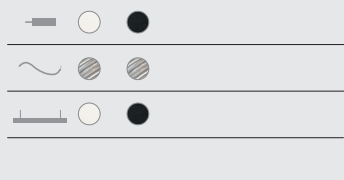



↑ **CODICE COMPLETO DEL PRODOTTO NELLA FOTO**
FULL PRODUCT CODE AS SHOWN IN PICTURE
VOLLSTÄNDIGER CODE VOM ARTIKEL IM BILD

3085EOF | **NE** | **E2** | **B**

Codice
Code

Finitura
Finishing
Lackierung

Diffusore
Diffuser
Diffusor

Tonalità
Hue
Farbton



configurazione standard: / basic configuration: / Standard Konfiguration:

E2 Opale - Opal

 B 3000K

BV

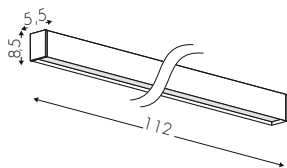

3085BOFBVE2B
3085BDMBVE2B

25W 1910lm* - 220V
DALI (Push) - 25W 1910lm - 220V

355,00 €
410,00 €

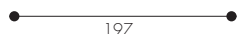

3085EOFBVE2B
3085EDMBVE2B

44W 3350lm - 220V
DALI (Push) - 44W 3350lm - 220V

482,00 €
542,00 €



3085GOFBVE2B
3085GDMBVE2B

56W 4305lm - 220V
DALI (Push) - 56W 4305lm - 220V

589,00 €
636,00 €

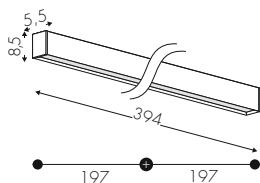

3085LOFBVE2B
3085LDMBVE2B

87W 6705lm - 220V
DALI (Push) - 87W 6705lm - 220V

1.059,00 €
1.209,00 €



3085MOFBVE2B
3085MDMBVE2B

111W 8605lm - 220V
DALI (Push) - 111W 8605lm - 220V

1.224,00 €
1.342,00 €



3085ROFBVE2B
3085RDMBVE2B

124W 17210lm - 220V
DALI (Push) - 124W 17210lm - 220V

2.607,00 €
2.943,00 €

Configura 

Configure / Konfigurieren

www.teamitaliailluminazione.it



 C 4000K

NE



A Alimentatore Incorporato - Incorporated Power Supply - Eingebautes Netzteil

* 1910lm effettivi - effective - effektive con - with - mit **E2**



 **CODICE COMPLETO DEL PRODOTTO NELLA FOTO**
FULL PRODUCT CODE AS SHOWN IN PICTURE • VOLLSTÄNDIGER CODE VOM ARTIKEL IM BILD

3080DOF **BV** **E2** **B**

Codice
Code

Finitura
Finishing
Lackierung

Diffusore
Diffuser
Diffusor

Tonalità
Hue
Farbton



configurazione standard: / basic configuration: / Standard Konfiguration:

E2 Opale - Opal

 B 3000K

BV

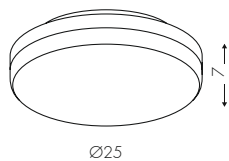

3080BOFBVE2B

12W 1300lm* - 220V

78,00 €

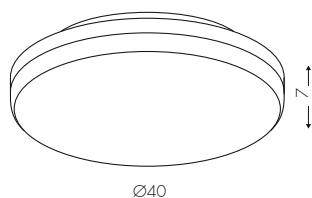

3080DOFBVE2B

30W 3000lm - 220V

148,00 €

Configura 

Configure / Konfigurieren

www.teamitaliailluminazione.it



A Alimentatore Incorporato - Incorporated Power Supply - Eingebautes Netzteil

* 1300lm effettivi - effective - effektiven con - with - mit **E2**



 **CODICE COMPLETO DEL PRODOTTO NELLA FOTO**
FULL PRODUCT CODE AS SHOWN IN PICTURE • VOLLSTÄNDIGER CODE VOM ARTIKEL IM BILD

3079BOF | **GV** | **E2** | **C**

Codice
Code

Finitura
Finishing
Lackierung

Diffusore
Diffuser
Diffusor

Tonalità
Hue
Farbton



configurazione standard: / basic configuration: / Standard Konfiguration:

E2 Opale - Opal

C 4000K

GV

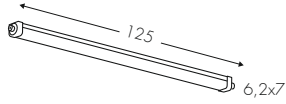

3079BOFGVE2C
3079BDMGVE2C

48W 6500lm* - 220V
DALI (Push) - 50W 5900lm - 220V

134,00 €
157,00 €

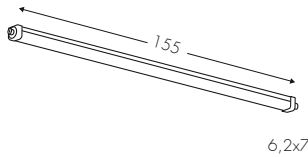

3079COFGVE2C
3079CDMGVE2C

75W 10000lm - 220V
DALI (Push) - 60W 8200lm - 220V

157,00 €
318,00 €

Configura



Configure / Konfigurieren

www.teamitaliailluminazione.it



A Alimentatore Incorporato - Incorporated Power Supply - Eingebautes Netzteil

* 6500lm effettivi - effective - effektive con - with - mit **E2**

Sistemi modulari
Modular systems
Modulare Systeme

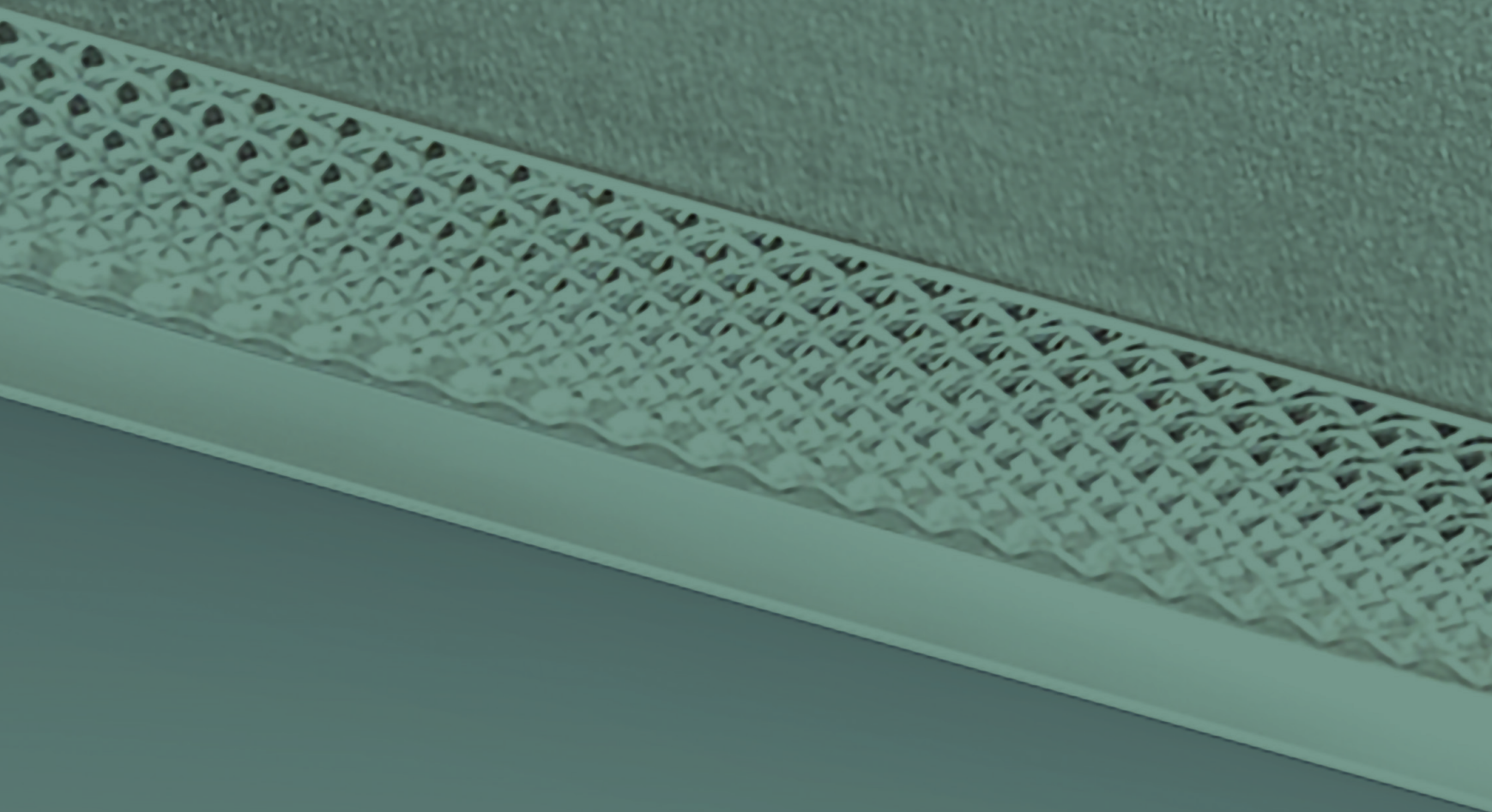

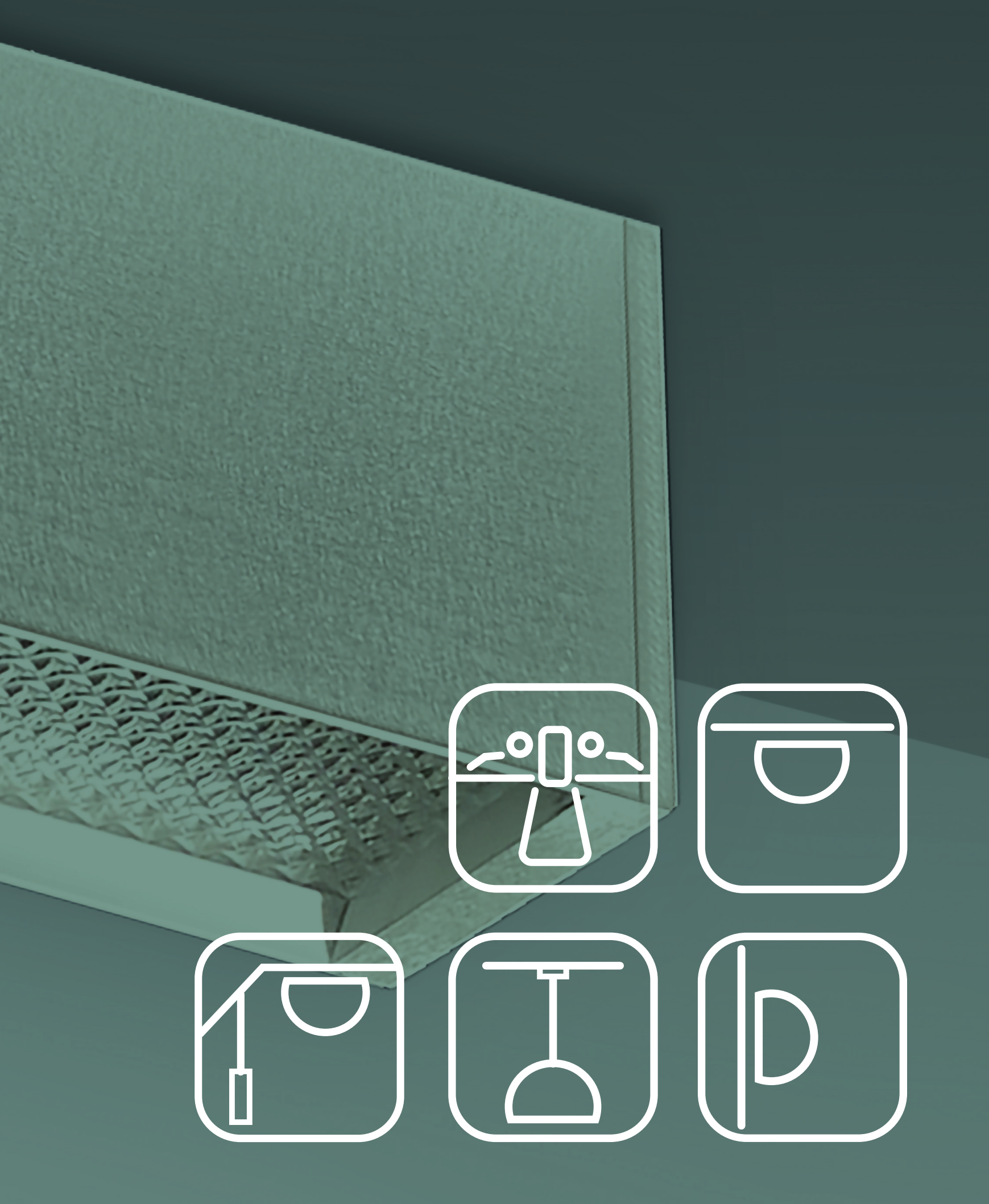



 **CODICE COMPLETO DEL PRODOTTO NELLA FOTO**
FULL PRODUCT CODE AS SHOWN IN PICTURE • VOLLSTÄNDIGER CODE VOM ARTIKEL IM BILD

1037KGR | **NE** | **E2** | **B**

Codice
Code

Finitura
Finishing
Lackierung

Diffusore
Diffuser
Diffusor

Tonalità
Hue
Farbton

EMME 24 DOWNLIGHT (3-10mt)

SOSPENSIONE
SUSPENSION LAMP
PENDELLEUCHTE



configurazione standard: / basic configuration: / Standard Konfiguration:

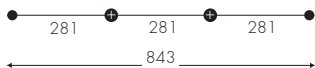
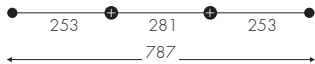
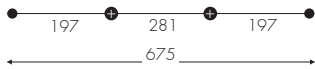
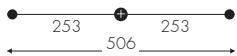
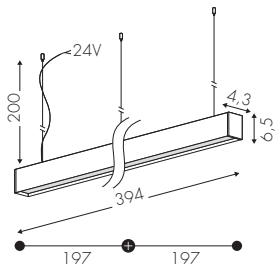

E2 Opale - Opal

B 3000K

BV



1037LBVE2B

87W 6705lm* - 24VDC

700,00 €

1037MBVE2B

111W 8605lm - 24VDC

760,00 €

1037NBVE2B

124W 9560lm - 24VDC

873,00 €

1037OBVE2B

148,5W 11485lm - 24VDC

1.157,00 €

1037PBVE2B

173W 13380lm - 24VDC

1.298,00 €

1037QBVE2B

185W 14340lm - 24VDC

1.358,00 €

1037RBVE2B

223W 17210lm - 24VDC

1.743,00 €

Configura

Configure / Konfigurieren

www.teamitaliailluminazione.it



E19 UGR<19 Prism

C 4000K

NE



Alimentatore non incluso - Power Supply not included - Netzteil nicht inbegriffen

Alimentatori a pag. 564-565 - Drivers p. 564-565 - Netzteil p. 564-565

* 6705lm effettivi - effective - effektive con - with - mit E2

7880lm effettivi - effective - effektive con - with - mit E19 +17,5%

KIT DRIVER

BV NE
■ ■

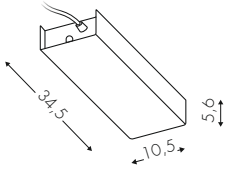

0-3 METRI

9037AOF
9037ADM
9037ATF

75W - 220V
DALI (Push) - 75W - 220V
75W - 220V

130,00 €
218,00 €
179,00 €

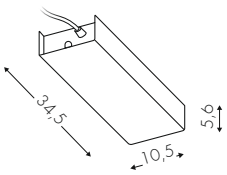

3-6 METRI

9037BOF
9037BDM
9037BTF

150W - 220V
DALI (Push) - 150W - 220V
150W - 220V

174,00 €
262,00 €
221,00 €

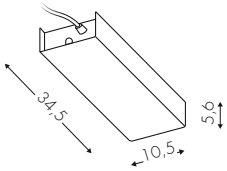

6-11 METRI

9037COF
9037CDM

240W - 220V
DALI (Push) - 240W - 220V

228,00 €
318,00 €



A Alimentatore Incorporato - Incorporated Power Supply - Eingebautes Netzteil

configurazione standard: / basic configuration: / Standard Konfiguration:

BV



E2 Opale - Opal

B 3000K

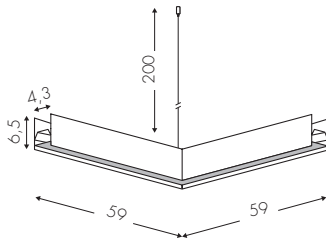

1037K**GABVE2B**

25W 1905lm* - 24VDC

345,00 €

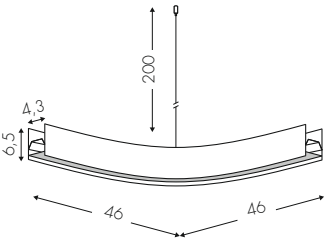

1037K**GRBVE2B**

18W 1235lm - 24VDC

345,00 €

Configura

Configure / Konfigurieren

www.teamitaliailluminazione.it



E19 UGR<19 Prism

C 4000K

NE



Alimentatore non incluso - Power Supply not included - Netzteil nicht inbegriffen

Alimentatori a pag. 564-565 - Drivers p. 564-565 - Netzteil p. 564-565

* 1905lm effettivi - effective - effektive con - with - mit E2

2240lm effettivi - effective - effektive con - with - mit E19 +17,5%



 **CODICE COMPLETO DEL PRODOTTO NELLA FOTO**
FULL PRODUCT CODE AS SHOWN IN PICTURE • VOLLSTÄNDIGER CODE VOM ARTIKEL IM BILD

1058DOF | **NE** | **E2** | **B**

Codice
Code

Finitura
Finishing
Lackierung

Diffusore
Diffuser
Diffusor

Tonalità
Hue
Farbton





configurazione standard: / basic configuration: / Standard Konfiguration:

E2 Opale - Opal

 B 3000K

BV

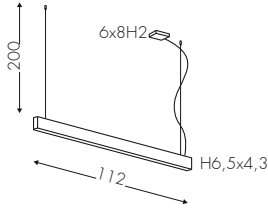

1058BOFBVE2B
1058BDMBVE2B

18W 2025lm* + 8W 1100lm - 220V
DALI (Push) - 18W 2025lm + 8W 1100lm - 220V

304,00 €
365,00 €



1058COFBVE2B
1058CDMBVE2B

22W 2530lm + 8W 1100lm - 220V
DALI (Push) - 22W 2530lm + 8W 1100lm - 220V

329,00 €
388,00 €



1058DOFBVE2B
1058DDMBVE2B

26W 3040lm + 16W 2200lm - 220V
DALI (Push) - 26W 3040lm + 16W 2200lm - 220V

356,00 €
430,00 €



1058EOFBVE2B
1058EDMBVE2B

31W 3540lm + 16W 2200lm - 220V
DALI (Push) - 31W 3540lm + 16W 2200lm - 220V

376,00 €
430,00 €

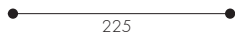

1058FOFBVE2B
1058FDMBVE2B

34W 4010lm + 16W 2200lm - 220V
DALI (Push) - 34W 4010lm + 16W 2200lm - 220V

424,00 €
498,00 €

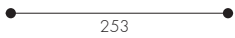

1058GOFBVE2B
1058GDMBVE2B

39W 4520lm + 16W 2200lm - 220V
DALI (Push) - 39W 4520lm + 16W 2200lm - 220V

463,00 €
534,00 €



1058HOFBVE2B
1058HDMBVE2B

43W 5080lm + 16W 2200lm - 220V
DALI (Push) - 43W 5080lm + 16W 2200lm - 220V

530,00 €
604,00 €

Configura 

Configure / Konfigurieren

www.teamitaliailluminazione.it



E19 UGR<19 Prism

 A 2700K  C 4000K



A Alimentatore Incorporato - Incorporated Power Supply - Eingebautes Netzteil

* 2025lm effettivi - effective - effektive con - with - mit E2
2380lm effettivi - effective - effektive con - with - mit E19  +17,5%

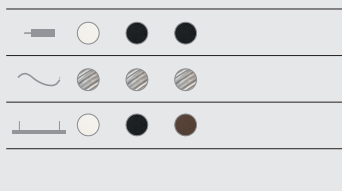



 CODICE COMPLETO DEL PRODOTTO NELLA FOTO
FULL PRODUCT CODE AS SHOWN IN PICTURE • VOLLSTÄNDIGER CODE VOM ARTIKEL IM BILD

10580OF | **NE** | **E2** | **B**

Codice
Code

Finitura
Finishing
Lackierung

Diffusore
Diffuser
Diffusor

Tonalità
Hue
Farbton





configurazione standard: / basic configuration: / Standard Konfiguration:

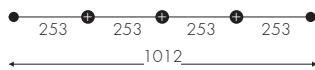
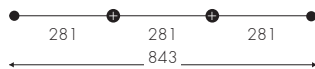
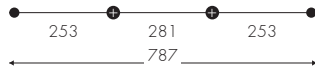
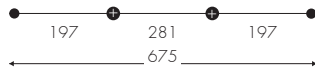
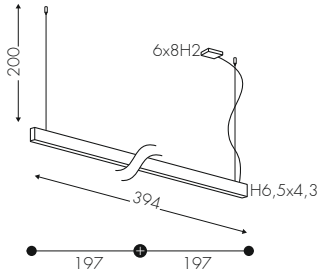

E2 Opale - Opal

● B 3000K

BV

1058LOFBVE2B
1058LDMBVE2B

62W 7080lm* + 32W 4400lm - 220V
DALI (Push) - 62W 7080lm + 32W 4400lm - 220V

766,00 €
877,00 €

1058MOFBVE2B
1058MDMBVE2B

78W 9010lm + 32W 4400lm - 220V
DALI (Push) - 78W 9010lm + 32W 4400lm - 220V

944,00 €
1.088,00 €

1058NOFBVE2B
1058NDMBVE2B

86W 10155lm + 32W 4400lm - 220V
DALI (Push) - 86W 10155lm + 32W 4400lm - 220V

1.080,00 €
1.231,00 €

1058OOFBVE2B
1058ODMBVE2B

105W 12160lm + 48W 6600lm - 220V
DALI (Push) - 105W 12160lm + 48W 6600lm - 220V

1.306,00 €
1.492,00 €

1058POFBVE2B
1058PDMBVE2B

121W 14095lm + 48W 6600lm - 220V
DALI (Push) - 121W 14095lm + 48W 6600lm - 220V

1.483,00 €
1.704,00 €

1058QOFBVE2B
1058QDMBVE2B

129W 15230lm + 48W 6600lm - 220V
DALI (Push) - 129W 15230lm + 48W 6600lm - 220V

1.620,00 €
1.847,00 €

1058ROFBVE2B
1058RDMBVE2B

156W 18030lm + 64W 8800lm - 220V
DALI (Push) - 156W 18030lm + 64W 8800lm - 220V

1.887,00 €
2.176,00 €

Configura

Configure / Konfigurieren

www.teamitaliailluminazione.it



E19 UGR<19 Prism

● A 2700K C 4000K

NE RU

A Alimentatore Incorporato - Incorporated Power Supply - Eingebautes Netzteil

*7080lm effettivi - effective - effektive con - with - mit E2
8330lm effettivi - effective - effektive con - with - mit E19 ↻ +17,5%





 **CODICE COMPLETO DEL PRODOTTO NELLA FOTO**
FULL PRODUCT CODE AS SHOWN IN PICTURE • VOLLSTÄNDIGER CODE VOM ARTIKEL IM BILD

1058GAOF | **NE** | **E2** | **B**

Codice
Code

Finitura
Finishing
Lackierung

Diffusore
Diffuser
Diffusor

Tonalità
Hue
Farbton





configurazione standard: / basic configuration: / Standard Konfiguration:

E2 Opale - Opal

 B 3000K

BV

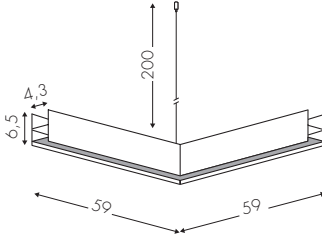

1058KGAOFBVE2B
1058KGADMBVE2B

18W 2025lm* - 220V
DALI (Push) - 18W 2025lm - 220V

454,00 €
520,00 €

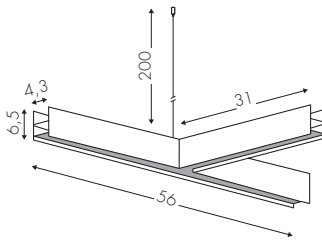

1058KGTOFBVE2B
1058KGTDMBVE2B

14W 1575lm - 220V
DALI (Push) - 14W 1575lm - 220V

563,00 €
634,00 €

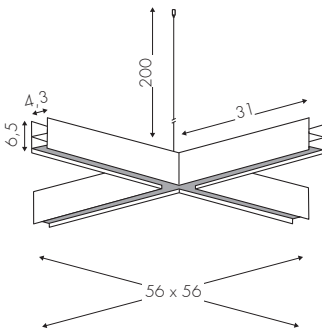

1058KGC OFBVE2B
1058KGC DMBVE2B

18W 2025lm - 220V
DALI (Push) - 18W 2025lm - 220V

741,00 €
817,00 €

Configura  Configure / Konfigurieren

www.teamitaliailluminazione.it 



E19 UGR<19 Prism  A 2700K C 4000K

NE RU

BV NE RU

A Alimentatore Incorporato - Incorporated Power Supply - Eingebautes Netzteil

* 2025lm effettivi - effective - effektive con - with - mit E2
2380lm effettivi - effective - effektive con - with - mit E19  +17,5%

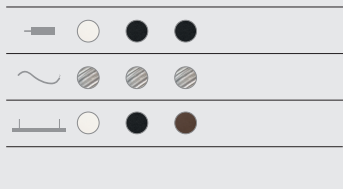



 CODICE COMPLETO DEL PRODOTTO NELLA FOTO
FULL PRODUCT CODE AS SHOWN IN PICTURE • VOLLSTÄNDIGER CODE VOM ARTIKEL IM BILD

4030DOF

Codice
Code

BV

Finitura
Finishing
Lackierung

E2

Diffusore
Diffuser
Diffusor

B

Tonalità
Hue
Farbton



configurazione standard: / basic configuration: / Standard Konfiguration:

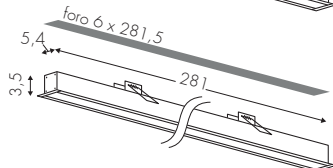
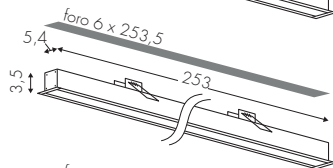
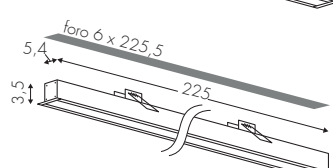
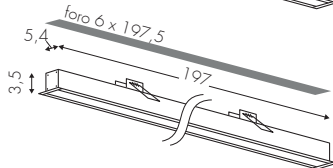
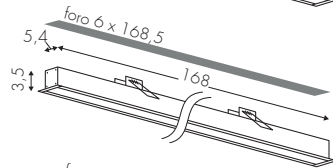
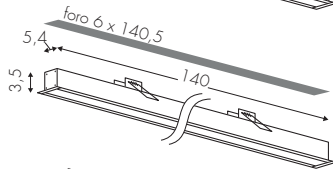
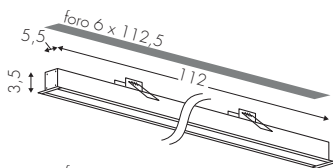
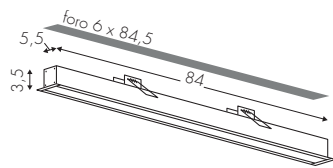

E2 Opale

B 3000K

BV

4030AOFBVE2B	26W 2260lm* - 220V	329,00 €
4030ADMBVE2B	DALI(Push) 26W 2260lm - 220V	374,00 €
4030BOFBVE2B	35W 3010lm - 220V	336,00 €
4030BDMBVE2B	DALI(Push) 35W 3010lm - 220V	391,00 €
4030COFBVE2B	44W 3765lm - 220V	379,00 €
4030CDMBVE2B	DALI(Push) 44W 3765lm - 220V	435,00 €
4030DOFBVE2B	53W 4515lm - 220V	395,00 €
4030DDMBVE2B	DALI(Push) 53W 4515lm - 220V	464,00 €
4030EOFBVE2B	62W 5265lm - 220V	411,00 €
4030EDMBVE2B	DALI(Push) 62W 5265lm - 220V	469,00 €
4030FOFBVE2B	70W 6020lm - 220V	508,00 €
4030FDMBVE2B	DALI(Push) 70W 6020lm - 220V	567,00 €
4030GOFBVE2B	79W 6775lm - 220V	566,00 €
4030GDMBVE2B	DALI(Push) 79W 6775lm - 220V	641,00 €
4030HOFBVE2B	88W 7525lm - 220V	613,00 €
4030HDMBVE2B	DALI(Push) 88W 7525lm - 220V	660,00 €

Configura

Configure / Konfigurieren

www.teamitaliailluminazione.it



Opal E19 UGR<19 Prism

C 4000K

NE

Alimentatore Incluso in remoto - Remote Power Supply - Fernspeisung enthalten

* 2260lm effettivi - effective - effektive con - with - mit E2
2655lm effettivi - effective - effektive con - with - mit E19 +17,5%

MIRÓ INCASSO

configurazione standard: / basic configuration: / Standard Konfiguration:

BV

E2 Opale

 B 3000K

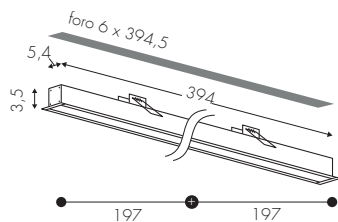

4030LOFBVE2B

123W 10530lm - 220V

822,00 €

4030LDMBVE2B

DALI(Push) 123W 10530lm - 220V

937,00 €

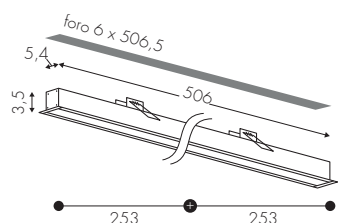

4030MOFBVE2B

158W 13550lm - 220V

1.132,00 €

4030MDMBVE2B

DALI(Push) 158W 13550lm - 220V

1.281,00 €

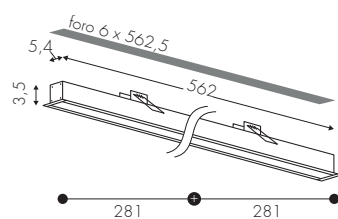

4030NOFBVE2B

176W 15050lm - 220V

1.225,00 €

4030NDMBVE2B

DALI(Push) 176W 15050lm - 220V

1.320,00 €

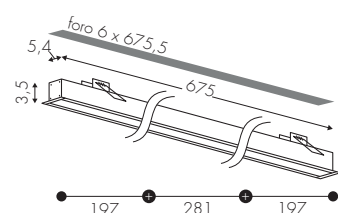

4030OOFBVE2B

212W 18060lm - 220V

1.435,00 €

4030ODMBVE2B

DALI(Push) 212W 18060lm - 220V

1.597,00 €

Configura 

Configure / Konfigurieren

www.teamitaliailluminazione.it



Opal E19 UGR<19 Prism

 C 4000K

NE



 Alimentatore Incluso in remoto - Remote Power Supply - Fernspeisung enthalten

CODICE COMPLETO - COMPLETE CODE - VOLLSTÄNDIGE CODE

4030LOF

Codice
Code

BV

Finitura
Finishing
Lackierung

E2

Diffusore
Diffuser
Diffusor

B

Tonalità
Hue
Farbton

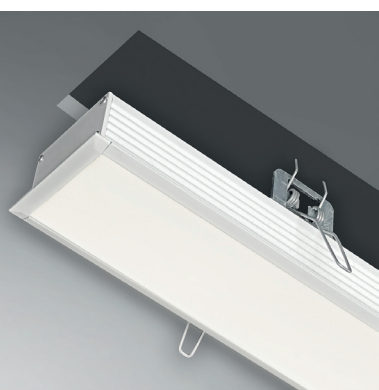



configurazione standard: / basic configuration: / Standard Konfiguration:

BV

E2 Opale

B 3000K

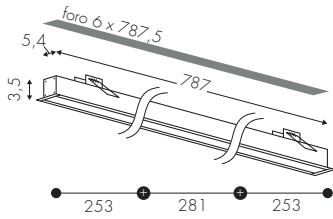

4030POFBVE2B

246W 21070lm* - 220V

1.744,00 €

4030PDMBVE2B

DALI(Push) 246W 21070lm - 220V

1.941,00 €

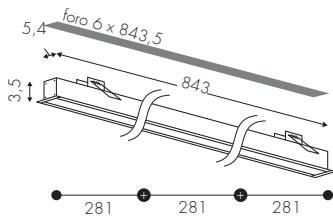

4030QOFBVE2B

264W 22575lm - 220V

1.838,00 €

4030QDMBVE2B

DALI(Push) 264W 22575lm - 220V

1.979,00 €

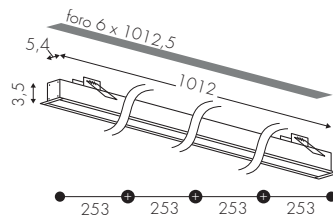

4030ROFBVE2B

317W 27090lm - 220V

2.195,00 €

4030RDMBVE2B

DALI(Push) 317W 27090lm - 220V

2.561,00 €

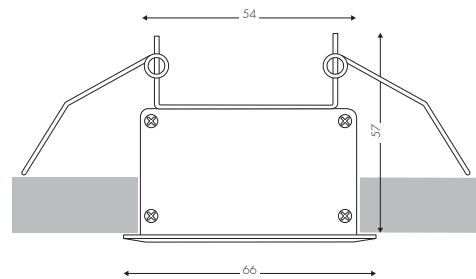

Configura

Configure / Konfigurieren

www.teamitaliailluminazione.it



Opal E19 UGR<19 Prism

C 4000K

NE



Alimentatore Incluso in remoto - Remote Power Supply - Fernspeisung enthalten

* 21070lm effettivi - effective - effektive con - with - mit E2
24780lm effettivi - effective - effektive con - with - mit E19 +17,5%



 CODICE COMPLETO DEL PRODOTTO NELLA FOTO
FULL PRODUCT CODE AS SHOWN IN PICTURE • VOLLSTÄNDIGER CODE VOM ARTIKEL IM BILD

4030KGAOF | **BV** | **E2** | **B**

Codice
Code

Finitura
Finishing
Lackierung

Diffusore
Diffuser
Diffusor

Tonalità
Hue
Farbton



configurazione standard: / basic configuration: / Standard Konfiguration:

E2 Opale

B 3000K

BV

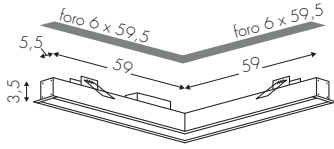

4030KGAOFBVE2B

35W 3010lm* - 220V

430,00 €

4030KGADMBVE2B

DALI(Push) 35W 3010lm - 220V

495,00 €

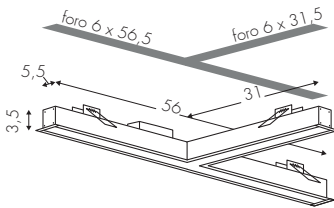

4030KGT OFBVE2B

26W 2250lm - 220V

535,00 €

4030KGTDMBVE2B

DALI(Push) 26W 2250lm - 220V

602,00 €

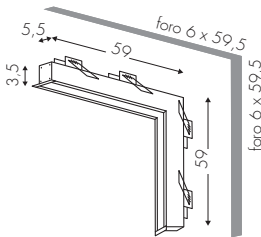

4030KGV OFBVE2B

35W 3010lm - 220V

430,00 €

4030KGVDMBVE2B

DALI(Push) 35W 3010lm - 220V

495,00 €

Configura

Configure / Konfigurieren

www.teamitaliailluminazione.it



Opal E19 UGR<19 Prism

C 4000K

NE

Alimentatore Incluso in remoto - Remote Power Supply - Fernspeisung enthalten

* 3010lm effettivi - effective - effektive con - with - mit E2

3540lm effettivi - effective - effektive con - with - mit E19 +17,5%

Sistema binario 48V
Track system 48V
Gleis 48V



LED Driver Constant Voltage



UPLIGHT



T3082A48NTE2B

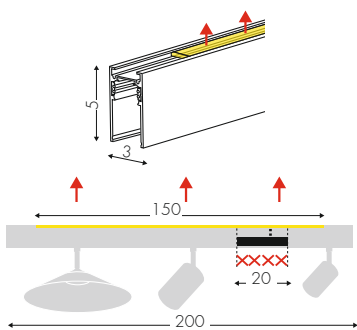

9074U48

Uplight track sospensione 48V DC (2mt) - 33W 4000lm
 Uplight suspension track 48V DC (2mt) - 33W 4000lm

248,00 €

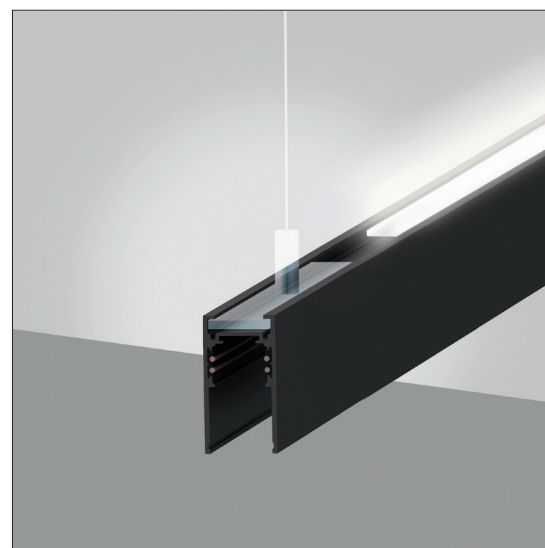

CODICE COMPLETO - COMPLETE CODE - VOLLSTÄNDIGE CODE

9074U48 **NE**

Codice
Code

Finitura
Finishing
Lackierung



 **CODICE COMPLETO DEL PRODOTTO NELLA FOTO**
FULL PRODUCT CODE AS SHOWN IN PICTURE • VOLLSTÄNDIGER CODE VOM ARTIKEL IM BILD

T3082A48 | **NE** | **E2** | **B**

Codice
Code

Finitura
Finishing
Lackierung

Diffusore
Diffuser
Diffusor

Tonalità
Hue
Farbton

configurazione standard: / basic configuration: / Standard Konfiguration:



E2 Opale - Opal - Opal

 B 3000K



T1082A48BVE2B

6,5W 680lm* - 48VDC

310,00 €



T3082A48BVE2B

6,5W 680lm - 48VDC

310,00 €



0074A2

Servizio doppia accensione
Dual switch service - Service Doppelzündung

50,00 €

 **C005T2NE**

Custom black cable

8,00 € /MT

Configura 

Configure / Konfigurieren

www.teamitaliailluminazione.it



A

 A 2700K

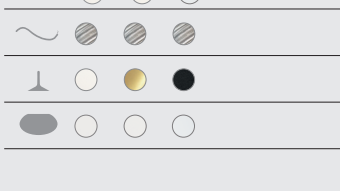

TF Taglio di Fase - Phase-Cut Dimmer - Phasenabschrittdimmer

A Alimentatore nel rosone - Power Supply inside the ceiling rose - Netzteil in der Deckendose

* 680lm effettivi - effective - effektive con - with - mit **E2**



 **CODICE COMPLETO DEL PRODOTTO NELLA FOTO**
FULL PRODUCT CODE AS SHOWN IN PICTURE • VOLLSTÄNDIGER CODE VOM ARTIKEL IM BILD

T071A48

Codice
Code

ZN

Finitura
Finishing
Lackierung

E19

Diffusore
Diffuser
Diffusor

B

Tonalità
Hue
Farbton



SISTEMA B48

LAMBDA 

configurazione standard: / basic configuration: / Standard Konfiguration:

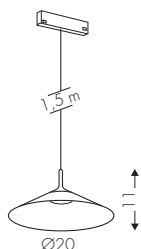

E19 Prismatico - Prism

 B 3000K



T071A48ONE19B

6.5W 800lm* - 48V DC

292,00 €

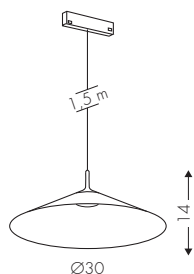

T071B48ONE19B

6.5W 800lm - 48V DC

372,00 €



T071F48ONE19B

6.5W 800lm - 48V DC

292,00 €

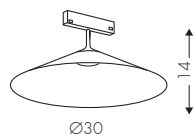

T071G48ONE19B

6.5W 800lm - 48V DC

372,00 €



0074A2

Servizio doppia accensione
Dual switch service - Service Doppelzündung

50,00 €

Configura 

Configure / Konfigurieren

www.teamitaliailluminazione.it



 Alimentatore non incluso - Power Supply not included - Netzteil nicht enthalten

* 800lm effettivi - effective - effektive con - with - mit E19

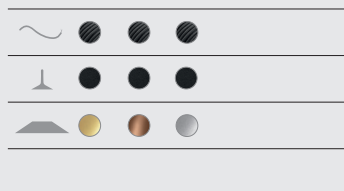



 CODICE COMPLETO DEL PRODOTTO NELLA FOTO
FULL PRODUCT CODE AS SHOWN IN PICTURE • VOLLSTÄNDIGER CODE VOM ARTIKEL IM BILD

T073A48

Codice
Code

NF

Finitura
Finishing
Lackierung

E2

Diffusore
Diffuser
Diffusor

B

Tonalità
Hue
Farbton



SISTEMA B48

configurazione standard: / basic configuration: / Standard Konfiguration:

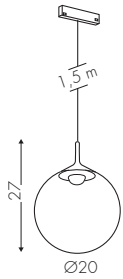

E2 Opale - Opal

 B 3000K



T073A48NTE2B

6.5W 800lm* - 48V DC

350,00 €

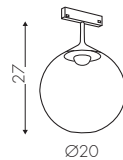

T073F48NTE2B

6.5W 800lm - 48V DC

350,00 €



0074A2

Servizio doppia accensione
Dual switch service - Service Doppelzündung

50,00 €

Configura 

Configure / Konfigurieren

www.teamitaliailluminazione.it



E2 Opale - Opal

 B 3000K



 Alimentatore non incluso - Power Supply not included - Netzteil nicht enthalten

* 800lm effettivi - effective - effektive con - with - mit **E2**

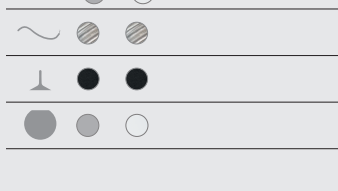

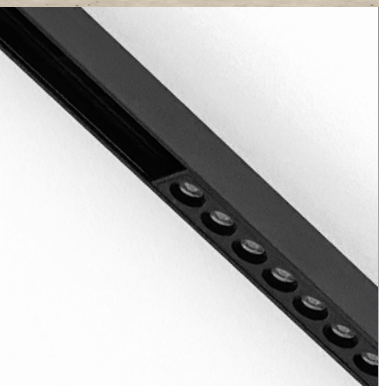

 **CODICE COMPLETO DEL PRODOTTO NELLA FOTO**
FULL PRODUCT CODE AS SHOWN IN PICTURE
VOLLSTÄNDIGER CODE VOM ARTIKEL IM BILD

T021A48 | **NE** | **E19** | **B**

Codice
Code

Finitura
Finishing
Lackierung

Diffusore
Diffuser
Diffusor

Tonalità
Hue
Farbton

SISTEMA B48

LINEA DARK

configurazione standard: / basic configuration: / Standard Konfiguration:

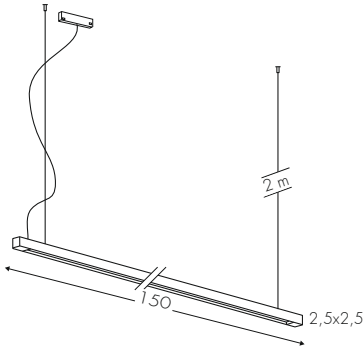

E19 Prismatizzato - Prism

 B 3000K

T021A48BVE19B

27W 2320lm* - 48V DC

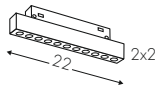

T021F48BVE19B

10W - 900lm - 48VDC

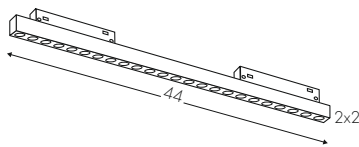

T021G48BVE19B

20W - 1800lm - 48V DC



0074A2

Servizio doppia accensione
Dual switch service - Service Doppelzündung

Configura 

Configure / Konfigurieren

www.teamitaliailluminazione.it



BV NE
 

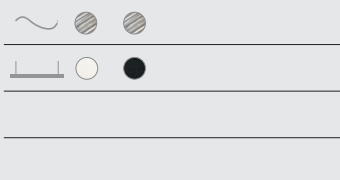

 Alimentatore non incluso - Power Supply not included - Netzteil nicht enthalten

* 2320lm effettivi - effective - effektive con - with - mit E19



 CODICE COMPLETO DEL PRODOTTO NELLA FOTO
FULL PRODUCT CODE AS SHOWN IN PICTURE • VOLLSTÄNDIGER CODE VOM ARTIKEL IM BILD

T3083A48 | **BV** | **E2** | **B**

Codice
Code

Finitura
Finishing
Lackierung

Diffusore
Diffuser
Diffusor

Tonalità
Hue
Farbton

SISTEMA B48

configurazione standard: / basic configuration: / Standard Konfiguration:

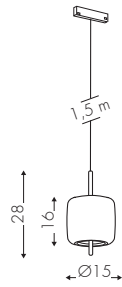

E2 Opale - Opal - Opal

 B 3000K



T1083A48BVE2B

6,5W 1000lm* - 48VDC

370,00 €

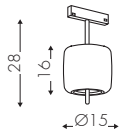

T3083A48BVE2B

6,5W 1000lm - 48VDC

370,00 €



0074A2

Servizio doppia accensione
Dual switch service - Service Doppelzündung

50,00 €

 **C005T2NE**

Custom black cable

8,00 € /MT

Configura 

Configure / Konfigurieren

www.teamitaliailluminazione.it



 A 2700K

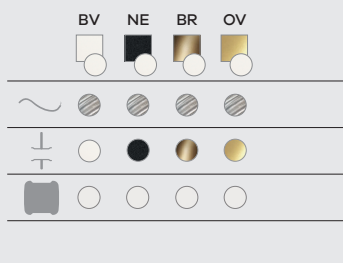

TF Taglio di Fase - Phase-Cut Dimmer - Phasenabschnittdimmer

A Alimentatore nel rosone - Power Supply inside the ceiling rose - Netzteil in der Deckendose

* 1000lm effettivi - effective - effektive con - with - mit **E2**

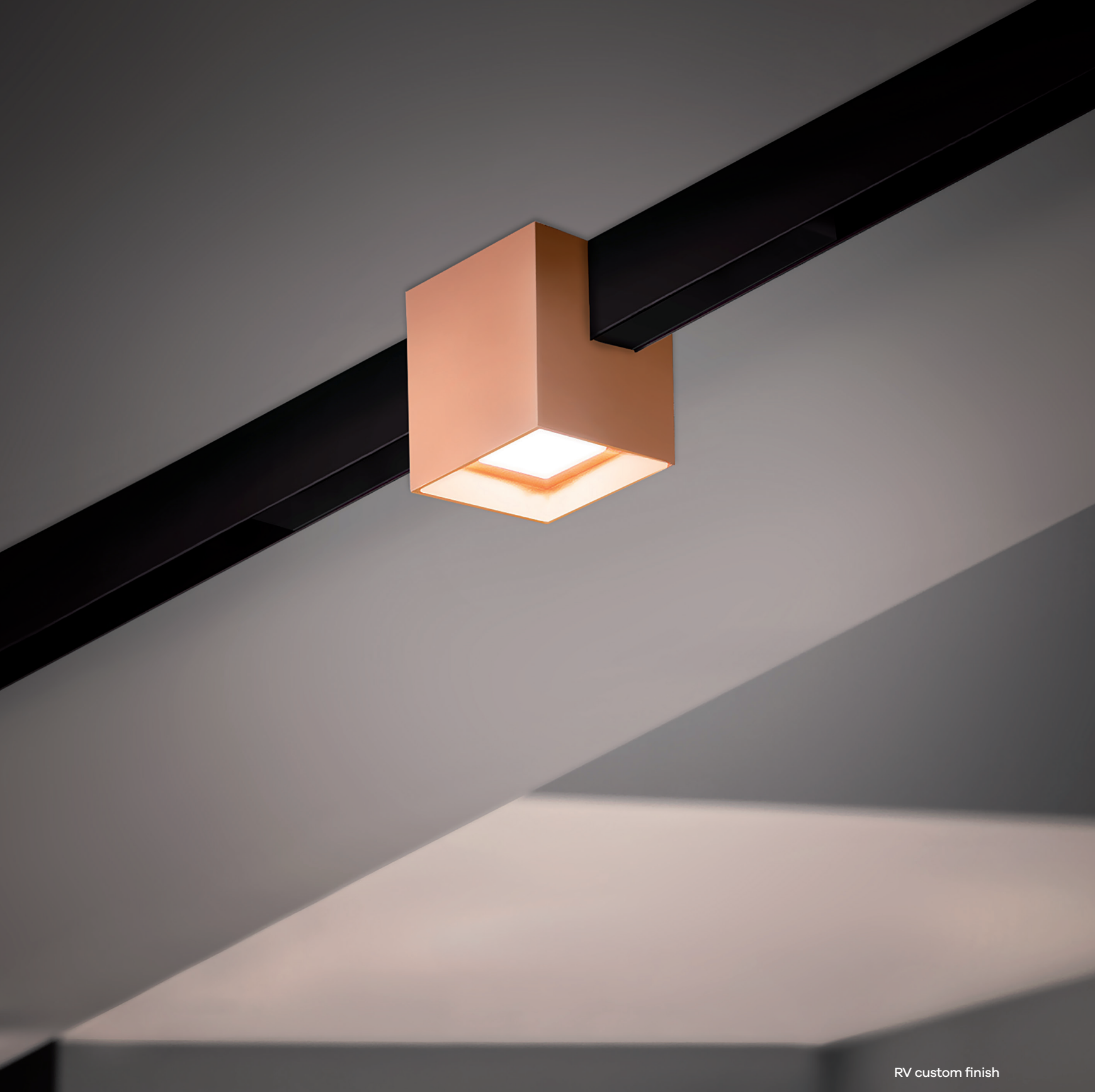

RV custom finish

 **CODICE COMPLETO DEL PRODOTTO NELLA FOTO**
FULL PRODUCT CODE AS SHOWN IN PICTURE • VOLLSTÄNDIGER CODE VOM ARTIKEL IM BILD

T009A48 | **RV** | **E28** | **B**

Codice
Code

Finitura
Finishing
Lackierung

Diffusore
Diffuser
Diffusor

Tonalità
Hue
Farbton

SISTEMA B48



configurazione standard: / basic configuration: / Standard Konfiguration:

E28 Satinato
Frosted - Satiniert

 **B** 3000K

BV

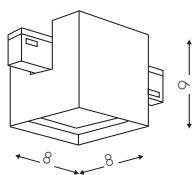
T009A48NEE28B

13W 1000lm* - 48V DC

199,00 €



0074A2

Servizio doppia accensione
Dual switch service - Service Doppelzündung

50,00 €

Configura 

Configure / Konfigurieren

www.teamitaliailluminazione.it



 Alimentatore non incluso - Power Supply not included - Netzteil nicht enthalten

* 1000lm effettivi - effective - effektive con - with - mit **E28**



 **CODICE COMPLETO DEL PRODOTTO NELLA FOTO**
FULL PRODUCT CODE AS SHOWN IN PICTURE • VOLLSTÄNDIGER CODE VOM ARTIKEL IM BILD

T068E48 | **OV** | **E2** | **B**

Codice
Code

Finitura
Finishing
Lackierung

Diffusore
Diffuser
Diffusor

Tonalità
Hue
Farbton

SISTEMA B48

configurazione standard: / basic configuration: / Standard Konfiguration:

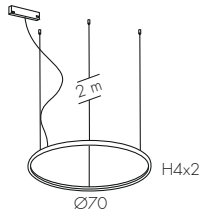

E2 Opale - Opal

 B 3000K



T068B48BVE2B

49W 3440lm* - 48V DC

595,00 €

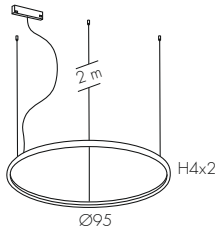

T068C48BVE2B

66W 5630lm - 48V DC

695,00 €

Configura 

Configure / Konfigurieren

www.teamitaliailluminazione.it



configurazione standard: / basic configuration: / Standard Konfiguration:

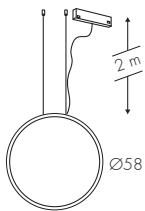

E2 Opale - Opal

 B 3000K

BV



T068O48BVE2B

39W 2680lm - 48V DC

520,00 €

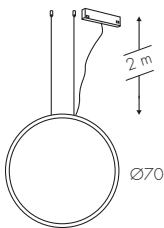

T068E48BVE2B

49W 3440lm - 48V DC

695,00 €



0074A2

Servizio doppia accensione
Dual switch service - Service Doppelzündung

50,00 €

Configura 

Configure / Konfigurieren

www.teamitaliailluminazione.it

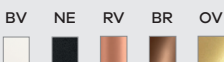

 Alimentatore non incluso - Power Supply not included - Netzteil nicht enthalten

* 3440lm effettivi - effective - effektive con - with - mit **E2**

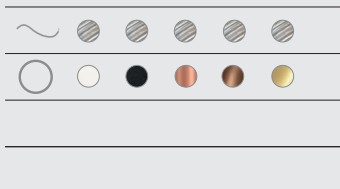



 **CODICE COMPLETO DEL PRODOTTO NELLA FOTO**
FULL PRODUCT CODE AS SHOWN IN PICTURE • VOLLSTÄNDIGER CODE VOM ARTIKEL IM BILD

T018C48

Codice
Code

NE

Finitura
Finishing
Lackierung

24

Diffusore
Diffuser
Diffusor

B

Tonalità
Hue
Farbton



configurazione standard: / basic configuration: / Standard Konfiguration:

24° Ottica - Optic - Optik

 B 3000K

BV

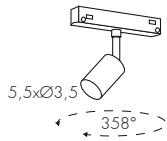

T018B48BV24B

4W 380lm* 48V DC

128,00 €

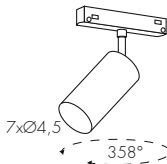

T018C48BV24B

7W 550lm 48V DC

131,00 €

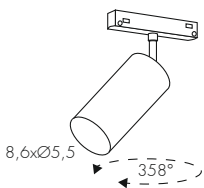

T018D48BV24B

12W 850lm 48V DC

145,00 €

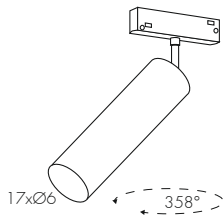

T018E48BV24B

18W 1280lm 48V DC

193,00 €



0074A2

Servizio doppia accensione
Dual switch service - Service Doppelzündung

50,00 €

Configura 

Configure / Konfigurieren

www.teamitaliailluminazione.it



NE

 Alimentatore non incluso - Power Supply not included - Netzteil nicht enthalten

* 380lm effettivi - effective - effektiven con - with - mit **24°**



standard

E8



optional

E19

↑ CODICE COMPLETO DEL PRODOTTO NELLA FOTO
FULL PRODUCT CODE AS SHOWN IN PICTURE
VOLLSTÄNDIGER CODE VOM ARTIKEL IM BILD

T069B48

Codice
Code

ZN

Finitura
Finishing
Lackierung

E19

Diffusore
Diffuser
Diffusor

B

Tonalità
Hue
Farbton

SISTEMA B48

TUBÍCO 

configurazione standard: / basic configuration: / Standard Konfiguration:

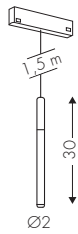

E8 Trasparente - Transparent

 B 3000K



T069A48ONE8B

3W 350lm* - 48V DC

235,00 €



T069B48ONE8B

3W 350lm - 48V DC

252,00 €

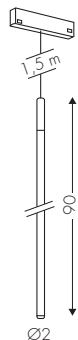

T069C48ONE8B

3W 350lm - 48V DC

265,00 €



0074A2

Servizio doppia accensione
Dual switch service - Service Doppelzündung

50,00 €

Configura 

Configure / Konfigurieren

www.teamitaliailluminazione.it



E19



 Alimentatore non incluso - Power Supply not included - Netzteil nicht enthalten

* 350lm effettivi - effective - effektiven con - with - mit **E8**





 **CODICE COMPLETO DEL PRODOTTO NELLA FOTO**
FULL PRODUCT CODE AS SHOWN IN PICTURE • VOLLSTÄNDIGER CODE VOM ARTIKEL IM BILD

T064A48 | **NF** | **E2** | **B**

Codice
Code

Finitura
Finishing
Lackierung

Diffusore
Diffuser
Diffusor

Tonalità
Hue
Farbton

SISTEMA B48

configurazione standard: / basic configuration: / Standard Konfiguration:

E2 Opale
Opal - Opal

 B 3000K

NT 

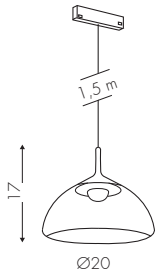

T064A48NTE2B

6.5W 800lm* - 48V DC

350,00 €

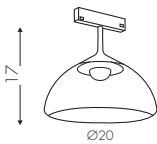

T064F48NTE2B

6.5W 800lm - 48V DC

350,00 €



0074A2

Servizio doppia accensione
Dual switch service - Service Doppelzündung

50,00 €

Configura 

Configure / Konfigurieren

www.teamitaliailluminazione.it



 Alimentatore non incluso - Power Supply not included - Netzteil nicht enthalten

* 800lm effettivi - effective - effektiven con - with - mit **E2**

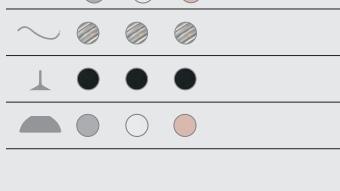



Sistemi di Gestione della luce
Light Management Systems
Lichtsteuersysteme



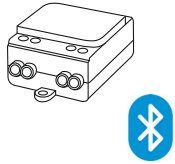

9010BTMD

Dispositivo Bluetooth per rendere dimmerabili Wireless da remoto i nostri prodotti in versione "DM" (DALI).

Our products DM dimmable (DALI) products are compatible with Tridonic module for remote bluetooth dimming.

Bluetooth-Gerät, um unsere "DM" (DALI) Produkte Wireless dimmbar zu machen.

163,00 €

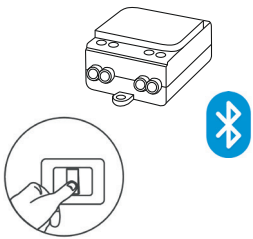

9010BTPD

Dispositivo per rendere Bluetooth un pulsante normalmente aperto.

Device to make Bluetooth a button normally open.

Gerät, um Bluetooth zu einer normalweise geöffneten Taste zu machen.

163,00 €

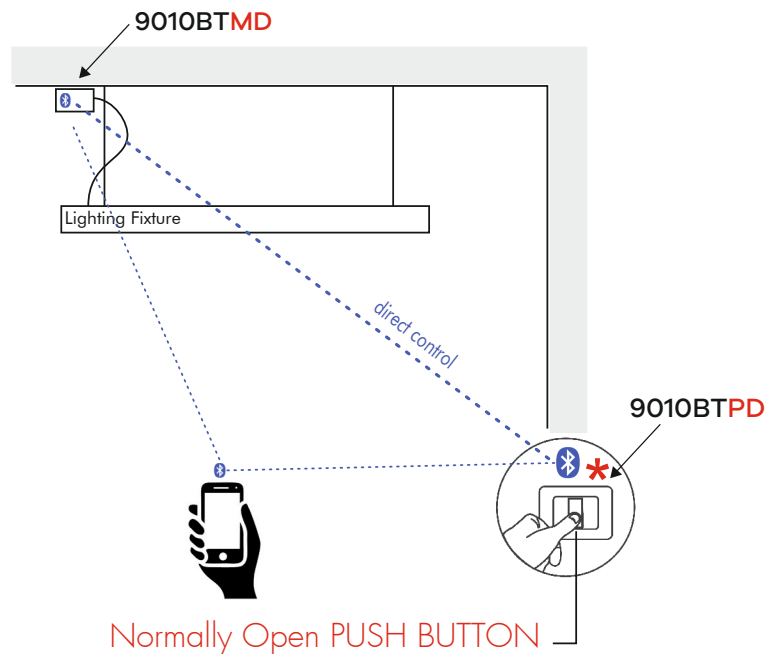

CODICE COMPLETO • COMPLETE CODE • VOLLSTÄNDIGE CODE

9010BTMD

Codice
Code

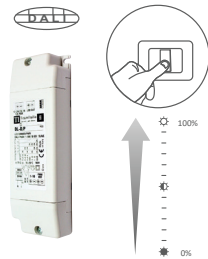

Max 10A 12/24VDC

90106002

Dispositivo per la gestione di sorgenti led a luce monocromatica con Pulsante o con sistema Domotico DALI.

Monochromatic led light manager with button or DALI domotic system.

Gerät für die Verwaltung von monochromatischem led-Lichtquellen mit Druckknopfschaltung oder DALI Domotik.

79,00 €

Dispositivi necessari - Necessary devices - Notwendige Geräte

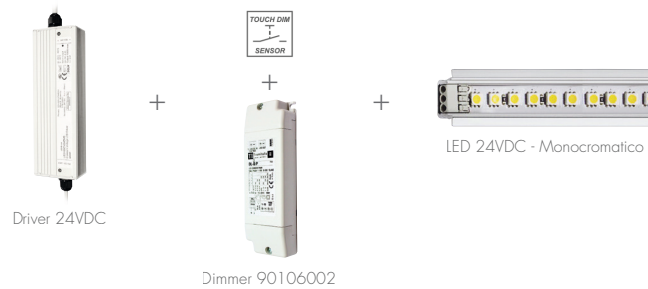

Driver 24VDC

Dimmer 90106002

LED 24VDC - Monocromatico

CODICE COMPLETO • COMPLETE CODE • VOLLSTÄNDIGE CODE

90106002

Codice
Code

Accessori
Accessoires
Zubehör



an Dist., O., LTD.
com/manual.html

V-(BLACK) ○

(RED) ○

5



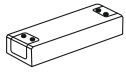

ON/OFF

AE006A	Driver 10W - On/Off 350mA / 35V / IP20	16,00 €
AE006B	Driver 16W - On/Off 350mA / 12-44V / IP20	28,00 €
AE006C	Driver 35W - On/Off 500mA / 50-100V IP20	26,00 €
AE006D	Driver 9W - On/Off 250mA / 5-36V IP20	22,00 €
AE006E	Driver 6W - On/Off 150mA / 5-40V IP20	22,00 €
AE006F	Driver 20W - On/Off 500mA / 12-44V IP20	27,00 €
AE006G	Driver 24W - On/Off 200-700mA / 3-42V IP20	35,00 €
AE006H	Driver 30W - On/Off 700mA / 20-42V IP20	31,00 €
AE006I	Driver 4W - On/Off 350mA / 3-12V / IP65	13,00 €
AE006L	Driver 10W - On/Off 350mA / 2-28,5V IP65	100,00 €
AE006M	Driver 18W - On/Off 350mA / 2-49V IP65	59,00 €
AE006N	Driver 34W - On/Off 300-700mA / IP20	30,00 €
AE006O	Driver 15W - On/Off 350-725mA / IP20	32,00 €

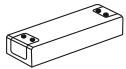

TRIAC

AE007F	Driver 25W - Triac 250-700mA / 15-49V IP20	56,00 €
AE008A	Driver 10W - Triac 350mA / 12-28V IP20	26,00 €
AE008B	Driver 18W - Triac 350mA / 25-51V IP20	26,00 €
AE008C	Driver 40W - Triac 350mA / 53-108V IP20	24,00 €
AE008D	Driver 10W - Triac 350mA / 3-42V IP20	18,00 €
AE008E	Driver 21W - Triac 300-500mA / 28-42V IP20	24,00 €
AE008F	Driver 20W - Triac 150-700mA / 7-44V IP20	44,00 €
AE008G	Driver 20W - Triac 180-350mA / 28-42V IP20	25,00 €
AE008H	Driver 20W - Triac 250-900mA / 15-48V IP20	46,00 €

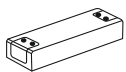

DALI (Push)

AE007A	Driver 30W - DALI(Push) 250-700mA / 2-54V IP20	65,00 €
AE007B	Driver 25W - DALI(Push) 350-1050mA / 20-50V IP20	62,00 €
AE007C	Driver 10W - DALI(Push) 150-400mA / 15-40V IP20	55,00 €
AE007E	Driver 38W - DALI(Push) 300-1050mA / 10-54V IP20	58,00 €



CODICE COMPLETO • COMPLETE CODE • VOLLSTÄNDIGE CODE

AE006I

Codice
Code

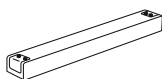

24V ON/OFF

AE003A	Driver 30W - On/Off 24V / IP20	29,00 €
AE003B	Driver 75W - On/Off 24V / IP20	45,00 €
AE003C	Driver 100W - On/Off 24V / IP65	74,00 €
AE003D	Driver 150W - On/Off 24V / IP65	98,00 €
AE003E	Driver 240W - On/Off 24V / IP65	127,00 €
AE003F	Driver 36W - On/Off 24V / IP20	34,00 €
AE003G	Driver 75W - On/Off 24V / IP65	52,00 €
AE003H	Driver 60W - On/Off 24V / IP20	38,00 €
AE003I	Driver 30W - On/Off 24V / IP65	47,00 €

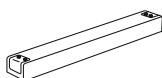

24V DALI

AE004A	Driver 150W - DALI (No-Push) 24V / IP65	113,00 €
---------------	---	-----------------

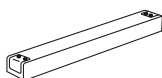

24V TRIAC

AE005A	Driver 100W - Triac 24V / IP20	124,00 €
AE005B	Driver 200W - Triac 24V / IP65	198,00 €

NEW

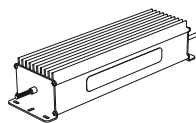

48V TRIAC

AE016A	Driver 100W - Triac 48V / IP65	230,00 €
AE016B	Driver 150W - Triac 48V / IP65	300,00 €

NEW

CODICE COMPLETO • COMPLETE CODE • VOLLSTÄNDIGE CODE

AE003A

Codice
Code

EMISSIONI LUMINOSE - LIGHT EMISSION - LICHEMISSIONEN



Superiore diffusa
Diffused uplight
Obere verbreitung



Superiore asimmetrica diffusa
Diffused asymmetrical uplight
Obere asymmetrisch verbreitung



Superiore concentrata
Accent uplight
Obere konzentriertes



Superiore asimmetrica concentrata
Accent asymmetrical uplight
Obere asymmetrisch konzentriertes



Inferiore diffusa
Diffused downlight
Geringere verbreitung



Inferiore asimmetrica diffusa
Accent asymmetrical downlight
Geringere asymmetrisch verbreitung



Inferiore concentrata
Accent downlight
Geringere konzentriertes



Inferiore asimmetrica concentrata
Accent asymmetrical downlight
Geringere asymmetrisch konzentriertes



Frontale diffusa
Diffuse frontlight
Diffuse front



Superiore diffusa + Inferiore diffusa
Diffuse up-downlight
Oben-unten diffusion



Indiretta posteriore
Indirect back
Indirektes Heck



Indiretta posteriore + frontale
Indirect back + front
Indirektes Heck + Front



Inferiore dominante + Superiore diffusa
Diffused main emission downlight + Uplight
Geringere hauptunterdiffusion + Obere verbreitung



Superiore diffusa + Inferiore concentrata
Diffused uplight + Diffused downlight
Obere verbreitung + Geringere konzentriertes



Inferiore diffusa + Superiore asimmetrica concentrata
Diffused Downlight + Accent asymmetrical uplight
Geringere verbreitung + Obere asymmetrisch konzentriertes



Superiore concentrata + Inferiore concentrata
Accent uplight + Accent downlight
Obere konzentriertes + Geringere konzentriertes



Superiore + Inferiore + Frontale diffusa
Diffuse up + down + frontal light
Obere + Geringere + front verbreitung



Inferiore + Laterale diffusa
Diffused side + Downlight
Obere asymmetrisch konzentriertes



360° diffusa
Diffused all side light
Auf vier seiten diffuses



Orientabile diffusa
Diffused adjustable
Verstellbar verbreitung



Orientabile concentrata
Accent adjustable
Verstellbar konzentriertes



Orientabile concentrata + Superiore diffusa
Accent adjustable + Diffuse up
Verstellbar konzentriertes + Obere







Laterale asimmetrico
Lateral Asymmetric
Seitliche asymmetrische







Laterale simmetrica
Lateral symmetric
Seitlich symmetrisch

SIMBOLI - SYMBOLS - SYMBOLE

-  Indica che un prodotto può circolare liberamente all'interno dell'Unione Europea: Certifica che il prodotto risponde ai requisiti essenziali di sicurezza.
Indicates that the product can circulate freely within the European Union: Certifies that the product meets the essential safety requirements.
Gibt an, dass ein Produkt innerhalb der Europäischen Union frei im Umlauf sein kann: Bescheinigt, dass das Produkt den wesentlichen Sicherheitsanforderungen entspricht.
-  Contatto a terra. Apparecchio in classe prima dotato solo dell'isolamento.
Ground contact. Fixture in first class equipped only with insulation.
Erdung Gerät in Klasse 1 nur mit Isolierung ausgerüstet.
-  Classe II doppio isolamento e/o isolamento rinforzato senza dispositivo di messa a terra.
Double insulation and/or reinforced insulation in every part and without ground devices.
Doppelte Isolierung, bzw verstärkte Isolierung der Teile, ohne Vorrichtung für Erdung.
-  Classe di protezione III - Apparecchi con bassa tensione protettiva. Apparecchi con protezione dallo shock elettrico attraverso la bassa tensione protettiva e che non funzionano con tensioni superiori.
Protection class III - Devices with extra-low voltage. Devices with protection from electric shock through the low-voltage protection. They don't work with higher voltages.
Schutzklasse III - Leuchten mit Kleinspannung. Geräte mit Schutz vor Stromschlag durch die Niederspannung. Sie arbeiten nicht mit höheren Spannungen.
-  Apparecchio adatto al montaggio su superfici normalmente infiammabili.
Suitable for mounting on normally inflammable surface.
Das Gerät ist zur Installation auf entflammable Oberflächen geeignet.
-  Protezione contro corpi estranei di medie dimensioni, nessuna protezione contro la penetrazione di acqua.
Protection against medium-sized foreign bodies, no protection against water penetration.
Schutz gegen mittelgroße Fremdkörper, ohne Schutz gegen Eindringen von Wasser.
-  Protetto contro la polvere. Protetto da spruzzi di ogni tipo.
Protected from dust ingress. Protected from water spray from any direction.
Staubgeschützt. Schutz gegen Spritzwasser.
-  Totalmente protetto contro la polvere. Protetto contro i getti d'acqua con lanci da tutte le direzioni.
Protected from total dust ingress. Protected from high pressure water jets from any direction.
Staubdicht. Schutz gegen starkes Strahlwasser.
-  Totalmente protetto contro la polvere. Protetto contro le ondate.
Protected from total dust ingress. Protected from high pressure water jets from any direction.
Staubdicht. Schutz gegen starkes Strahlwasser.
-  Totalmente protetto contro la polvere. Protetto contro gli effetti di immersione.
Protected from total dust ingress. Protected from waves.
Staubdicht. Schutz gegen eintauchen.
-  Protetto contro energia d'urto 2J.
Protected against impact energy 2J.
Geschützt gegen Aufprallenergie 2J.
-  Protetto contro energia d'urto 5J.
Protected against impact energy 5J.
Geschützt gegen Aufprallenergie 5J.

-  A 2700K
-  B 3000K
-  C 4000K
-  D 2700K-6500K
-  E RGB

-  Alimentatore Incorporato
Incorporated Power Supply
Eingebautes Netzteil
-  Alimentatore nel rosone
Power Supply inside the ceiling rose
Netzteil in der Deckendose
-  Alimentatore Incluso in remoto
Included Power Supply in remote
Einbezogen Netzteil
-  Alimentatore non incluso
Power Supply not included
Netzteil nicht inbegriffen
- GU10** Sorgente GU10 non inclusa
GU10 light source not included
GU10 lichtquelle nicht einbezogen
- E27** Sorgente E27 non inclusa
E27 light source not included
E27 Lichtquelle nicht Enthalten

CAVO ALIMENTAZIONE
ELECTRIC CABLE - STROMKABEL



Nero - Black - Schwarz

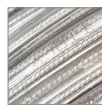

Trasparente - Transparent - Transparent



Rosso - Red - Rot



Bianco - White - Weiß

BV



Bianco
White
Weiß

NE



Nero
Black
Schwarz

RU



Ruggine
Rust
Rost

BF



Bronzo francese
French bronze
Französische Bronze

OS



Oro spazzolato
Brushed Gold
Gebürstetes Gold

OV



Oro verniciato
Painted gold
Gold lackiert

RV



Rame verniciato
Painted copper
Kupfer lackiert

BR

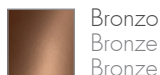

Bronzo
Bronze
Bronze

NT

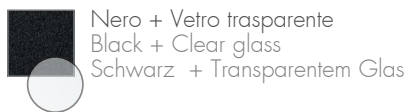

Nero + Vetro trasparente
Black + Clear glass
Schwarz + Transparentem Glas

SV



Salvia
Sage
Salbei

ZN



Nero + Bronzo
Black + Bronze
Schwarz + Bronze

OB



Oro verniciato + Bianco
Brushed Gold + White
Gebürstetes Gold + Weiß

ON



Oro verniciato + Nero
Brushed Gold + Black
Gebürstetes Gold + Schwarz

RN



Rame verniciato + Nero
Painted copper + Black
Kupfer lackiert + Schwarz

BN



Nero + Bianco
Black + White
Schwarz + Weiß

AB



Argento + Bianco
Silver + White
Silber + Weiß

AB



Argento + Nero
Silver + Black
Silber + Schwarz

PN



Platino + Nero
Platin + Black
Platin + Schwarz

NF

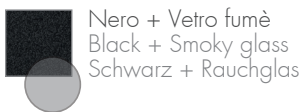

Nero + Vetro fumè
Black + Smoky glass
Schwarz + Rauchglas

BY



Blu Navy
Navy Blue
Blu Navy

SN



Salvia + Nero
Sage + Black
Salbei + Schwarz

CB

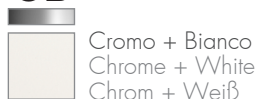

Cromo + Bianco
Chrome + White
Chrom + Weiß

BO



Bianco + Oca
White + Ochre
Weiß + Ocker

BS



Bianco + Salvia
White + Sage
Weiß + Salbei

BB



Bianco + Blu Navy
White + Navy Blue
Weiß + Blu Navy

AL



Alluminio
Aluminum
Aluminium

PL



Platino
Platinum
Platin

GV



Grigio verniciato
Painted Grey
Grau lackiert

NZ

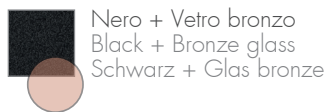

Nero + Vetro bronzo
Black + Bronze glass
Schwarz + Glas bronze

OC



Oca
Ochre
Ocker



via dell'Artigianato, 21
37066 Caselle di Sommacampagna - Verona (Italy)
Tel. +39 045 8581640
info@teamitaliailluminazione.it
teamitaliailluminazione.it

